

# Instruction Book *and* Repair List

INDEX ON NEXT PAGE



**KEEP THIS BOOKLET FOR FUTURE USE**

**Every Hercules Engine is Carefully Tested and  
Inspected to Insure Our Customers  
100% Service**

**The Life of Your Engine Depends on the  
Attention You Give it. Please Take Advantage  
of the Instructions We Give You in this Book**

**The Hercules Gas Engine Co.  
Evansville, Indiana.**

# INDEX.

## ENGINES.

Kerosene Engine	1
Gasoline Engine	34
High Quality	35

## KEROSENE ENGINE INSTRUCTIONS.

How to prepare for starting	2
How to start	2
How to stop	4
How to adjust carburetor	4

## GASOLINE ENGINE INSTRUCTIONS.

How to prepare for starting	5
How to start when magneto is used	28
How to start when batteries are used	6
Battery ignition instructions	6
How to adjust the gasoline fuel valve	10

## WEBSTER MAGNETO INSTRUCTIONS.

How to start engine with magneto	28
Care of magneto	30
How to set the spark	31

## KEROSENE OR GASOLINE ENGINE ADJUSTMENTS.

If engine will not start, or is hard to start	6
If engine dies down after starting	7
If engine has no power	7
Fuel, Clean Connections	9

## MISCELLANEOUS INSTRUCTIONS.

When the spark should take place	11
To start engine in cold weather	12
If water is the hopper should boil	13
How to put on the cam gear	13
The governor	15
Valves (general instructions on valves)	15
How to adjust the detent blade (gasoline engine)	13
How to adjust the detent blade catch block (gasoline engine)	14
How to adjust the cam rod spring	14
How to remove or replace fly wheel or pulley	14
Cylinder head (packing)	16
Main bearings (replacing)	16
Piston and rings (how to remove and replace rings)	17
Turn on Water	9

## CUTS.

Cuts of kerosene head and carburetor parts	20
Cuts of engine parts	18 to 20
Cuts of pump jack parts	25
Cuts of Webster magneto parts	27
Cuts of friction clutch pulley parts	26

## PRICES ON PARTS.

Engine repair part lists	21 to 24
Pump jack repair part list	25
Webster magneto repair part list	27
Friction clutch pulley repair part list	26

## FOUNDATION PLANS.

How to mount engine on solid foundation	32
---	----

## MISCELLANEOUS INFORMATION.

Rule for figuring size of pulleys	33
If you mount engine on truck, etc.	33
Capacity of fuel tanks	33

*Hercules Gas Engine Co.  
Evansville Ind*

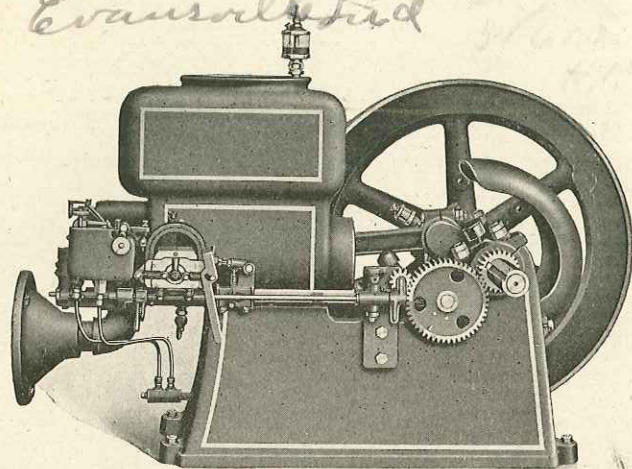

THE FOLLOWING IS A GENERAL DESCRIPTION OF THE THROTTLING GOVERNED KEROSENE ENGINE.

Sizes, 3, 5, 7, 9, 12 H. P.

Our 1½ H. P. is equipped with Hit-and-Miss Governor and is built to burn gasoline only.

**CYLINDER.** Semi-steel, accurately machined and reamed to perfect "gun barrel" finish, fitted with ground piston and rings, insuring perfect compression, and reducing friction to the lowest possible minimum. Cylinder is attached to main frame by means of machined tongue and groove method.

**MAIN FRAME.** Accurately machined, and reinforced across top under crank; contains heavy galvanized fuel tank.

**BEARINGS.** Main bearings, as well as crank pin bearing, are of the white bronze, **Removable** type, making it possible to replace them at any time.

**CAM.** Hardened steel attached to cam gear by being pressed over machined hub and riveted, can be replaced.

**GOVERNOR.** High speed, fly-ball type, pronounced by the most eminent authority in mechanical engineering as the most accurate, as well as the most economical governor ever used on an internal combustion engine.

**FUEL SUPPLY.** The fuel is drawn from the supply tank by means of a pump, which is built into the carburetor, holding fuel supply at a constant level, insuring a perfect mixture at all speeds.

**SPEED.** The **Kerosene Engine** is equipped with an effective speed changing device which enables the operator to change ten, twenty, fifty or a hundred revolutions per minute while engine is in operation.

The superior quality of the engine, the extremely attractive prices and the big saving in fuel cost, make this the most desirable engine obtainable.

## KEROSENE ENGINE INSTRUCTION

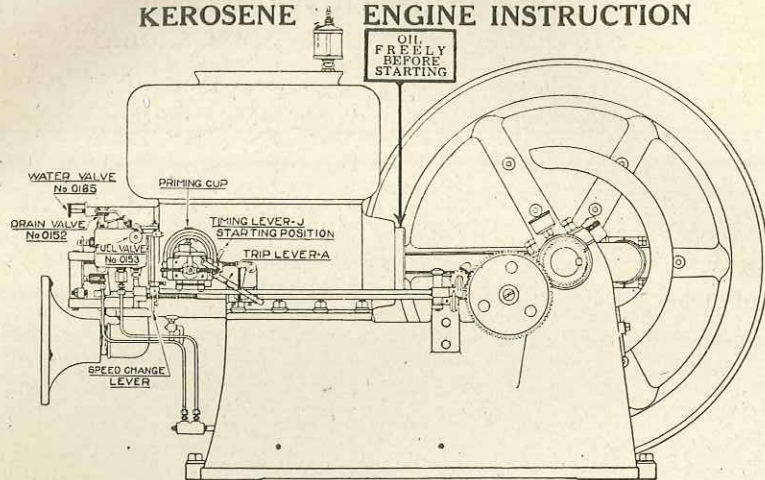

Figure 1.

### READ THE FOLLOWING BEFORE YOU START YOUR ENGINE.

#### HOW TO PREPARE KEROSENE ENGINE FOR STARTING.

Remove the plugs from the holes in the main and connecting rod bearings, clean them out thoroughly, also any other oil holes that you find.

Fill the grease cups and screw the tops of the cups down until the grease starts to come out of the bottom. Then put the cups in place on the engine and turn the top down two full turns, which forces the grease into the bearings.

Oil all movable parts thoroughly and turn the flywheels around two or three times to work the grease into the bearings. Oil the valve stems, **feed oil to oil hole in cam** also put a few drops on the igniter parts and work these parts by hand to be sure they are free from paint.

Fill the tank in engine base with kerosene.

Put just enough water in the water hopper to cover the cylinder about 2 inches. Close drain valve and fill the carburetor reservoir to the overflow with gasoline. Screw the lubricator into the pipe on top of the water reservoir, fill it with oil.

Turn on the oil by raising the lever on lubricator and adjust it so oil will flow freely. To increase the flow, turn adjusting collar just under the lever to the right; to decrease the flow, turn it to the left.

Drop small quantity of lubricating oil on plunger of fuel pump.

Before starting engine make sure all parts are properly oiled. Never use steam engine oil, use a good grade (high fire test) gas engine oil.

Under ordinary conditions we recommend that lubricator be set to feed as follows on both kerosene and gasoline engines:

H. P.	On Full Load.	On Light Load.
1½ and 3.	10 drops per minute.	5 drops per minute.
5 and 7.	20 drops per minute.	10 drops per minute.
9 and 12.	30 drops per minute.	15 drops per minute.

In cold weather warm the oil so that it will flow freely.

## KEROSENE ENGINE INSTRUCTIONS.

### DIRECTIONS FOR STARTING KEROSENE ENGINE.

**First.** Open the fuel valve (page 2). Open fuel valve one full turn, after engine is running adjust valve to mark on valve head.

**Second.** Place the timing lever "J" (Figure 12, page 28) in the starting position to prevent the engine from kicking back.

**Third.** Apply the starting crank and hold the intake valve open with the left hand, spin the flywheel rapidly five or six turns, release the intake valve but continue to crank the engine. At the same time partly close the air intake in the bottom of fuel reservoir with fingers of left hand until engine starts.

### HOW TO GET THE BEST RESULTS AFTER ENGINE IS STARTED.

Change the timing lever "J" (Figure 12, page 28) to the running position.

After you have the engine started and the fuel valves properly set, start on whatever work you have to do and run on load until water in the hopper steams, then add a little water from time to time until the water hopper is full. The engine will give the best results when the water steams, as heat helps to vaporize the kerosene.

### TURN ON WATER

Only after the engine has become hot and is working hard and you notice a slight knocking in the cylinder at each explosion, which is characteristic of all kerosene engines. To overcome this, open the water valve (page 2) in cylinder head, one notch at a time until the pounding has nearly ceased. Be careful not to use too much water in trying to entirely stop the knocking, as a little knock indicates good power, and too much water causes loss of power.

**We do not furnish starting cranks with the 9 or 12 horse power engines. Start these engines off compression.**

### TO START ENGINE OFF COMPRESSION.

**First.** Hold the intake valve open with the left hand and turn the flywheel to the right with the right hand until the igniter trips, then stop.

**Second.** Open the fuel valve No. 0153 (page 2). Open fuel valve one full turn after engine is running. Adjust valve to mark on valve head.

**Third.** Place the timing lever "J" (Figure 12, page 28) in the starting position to prevent the engine from kicking back. This retards spark.

**Fourth.** Cock the magneto with trip lever "A," as shown in Figure 11, page 28.

**Fifth.** Prime the cylinder by filling the priming cup twice with gasoline. In cold weather fill the cup two to three times, turn the flywheels to the right until the crank is on the outer dead center, as shown in Figure 14, page 28, then close priming cup.

**Sixth.** Take hold of the spoke in the flywheel at the top with your right hand and put your right foot on a spoke at the bottom. Pull with your hand and push with your foot, giving the wheel a quick turn back toward the cylinder, bringing the piston back against the compression as hard as possible. Release hold on flywheel with hand and foot and push down on trip lever "A" (Figure 11, page 28). **CAUTION**—Be sure to take hand and foot off flywheel before tripping magneto.

**Seventh.** As soon as the engine starts, shift the timing lever "J" to the running position. This advances spark.

## KEROSENE ENGINE INSTRUCTIONS.

### HOW TO STOP KEROSENE ENGINE.

**Be sure to drain the Carburetor when stopping engine.**

**First.** Close the No. 0137 water valve about five minutes before stopping the engine. This prevents cylinder from rusting and makes the engine easier to start.

**Second.** Close the fuel valve by turning to the right as far as it will go.

**Third.** Shut off the oil.

**Fourth.** Open the drain valve No. 0152.

**Fifth.** Turn flywheel until exhaust valve closes. This prevents corroding of valve seats and injury to cylinder.

In cold weather be sure to drain all the water out of the water hopper by opening the drain cock underneath the cylinder. Also remove No. 27 plug from bottom of cylinder head. **Be sure to do this, as even a light frost may crack the cylinder or head by freezing the water.**

If you are working your engine on a big job running all day, when you shut down at noon your engine will be very hot. If you do not take more than an hour for lunch, when returning to work you can start the engine on kerosene direct and will not have to use gasoline, as the engine will be hot enough to start on kerosene, in which case it will not be necessary to drain the carburetor reservoir when stopping the engine.

### HOW TO ADJUST KEROSENE CARBURETOR.

The kerosene carburetor is of the pump feed type. Kerosene being pumped up from the tank in the base by action of cam rod on pump lever.

The fuel is mixed with air drawn in from beneath carburetor and the feed to the cylinder head is regulated by a "butterfly" type valve.

Too little fuel will cause a popping sound at the mixer.

Too much fuel will cause a discharge of black smoke from muffler.

In case engine is not getting enough fuel after you have properly regulated fuel valve, drain carburetor by means of drain valve, remove No. 0158 pump body, **taking care not to lose the two check balls**, and clean pump body and connection carefully.

## GASOLINE ENGINE INSTRUCTIONS.

### TO GET ENGINE READY TO RUN.

Remove the plugs from the holes in the main and connecting rod bearings, clean them out thoroughly, also any other oil holes that you find.

Fill the grease cups with the sample grease we furnish and screw the tops of the cups down until the grease starts to come out of the bottom. Then put the cups in place on the engine and turn the top down two full turns, which forces the grease into the bearings.

Oil all movable parts thoroughly and turn the flywheels around two or three times to work the grease into the bearings. Oil the valve stems, **feed oil to oil hole in cam**, also put a few drops on the igniter parts and work these parts by hand to be sure they are free from paint.

Fill water hopper with clean water and the tank in the base with gasoline.

Screw the lubricator into the pipe on top of the water reservoir, fill it with oil. Raise the lever on the top of the lubricator straight up and adjust it so the oil will drop freely. To increase the flow of oil turn the adjusting collar, just under the lever, to the right; to decrease the flow turn it to the left.

Before starting engine make sure all parts are properly oiled. Never use steam engine oil; use a good grade (high fire test) gas engine oil. For quantity see page 2.

### TO ADJUST THE No. 63 AUTOMATIC GREASE CUP.

For summer use—cut down the amount of grease by turning the screw in the shank of the cup until the hole in the bottom of the cup is half closed. Fill the cup and before placing on the engine see how fast it feeds. A cup full of grease should last half a day.

For winter use—the hole in the bottom of the cup should be wide open. You can adjust the screw in the shank of the cup by trail, until you get the proper amount of grease for this bearing.

### HOW TO START A GASOLINE ENGINE WHEN BATTERIES ARE USED.

**First.** See that the battery wires are connected to the igniter on the engine and turn on the oil by raising the small lever on top of the lubricator. Be sure the oil is feeding properly.

**Second.** Turn flywheel until piston protrudes from cylinder and squirt oil in oil hole in piston. Use liberal amount of oil in cold weather.

**Third.** Open the fuel valve (Figure 3, page 10) one-half turn on  $1\frac{1}{2}$  H. P. and from one to two turns on larger sizes.

**Fourth.** Open the priming cup, if there is one on the engine, and turn the flywheels to the right until the detent blade on the governor can be pushed in behind the catch block on the cam rod and then close priming cup.

**Fifth.** Close the battery switch.

**Sixth.** Push the detent blade in behind the catch block on the cam rod and hold it there. Turn the flywheel around to the right rapidly five or six times and then release the detent blade, but continue to turn the flywheel until the engine starts.

**Starting cranks are furnished with  $1\frac{1}{2}$ , 3, 5 and 7-horse power engines only.**

**Seventh.** As soon as the engine starts open the air damper, close the fuel valve slowly until the point is reached where the engine runs with the least number of explosions and without black smoke appearing at the exhaust or a popping sound at the mixer. This popping sound is caused by an insufficient supply of fuel, and smoke at the exhaust by too much fuel.

## GASOLINE ENGINE INSTRUCTIONS—Continued.

### TO STOP THE ENGINE.

**First.** Shut off the gasoline by closing the fuel valve.

**Second.** Open the battery switch and shut off the oil by turning down the small lever on top of the lubricator.

**Third.** In cold weather drain the water from the reservoir by opening the drain cock underneath the cylinder, also remove plug from bottom of cylinder head. Be sure to do this, as even a light frost may crack the cylinder or cylinder head by freezing the water.

**Fourth.** Turn flywheel until exhaust valve closes. This prevents corroding of valve seats and injury to cylinder.

To start engine when magneto is used, see page 28.

## KEROSENE OR GASOLINE ENGINE INSTRUCTIONS.

### STOP—LOOK—LISTEN

If your engine does not give perfect satisfaction, do not call in an expert—read the following:

Every engine is carefully tested and inspected to insure our customers 100 per cent service.

Just before we shipped your engine it was gone over carefully and run to be sure that all parts were in proper adjustment and in perfect condition, so that when the engine reached you there would be no trouble in your running it, provided you did not change any of the parts from the way they were set when the engine reached you.

### If Engine Will Not Start or is Hard to Start.

An engine to give satisfactory results must get a good mixture of fuel and a good spark, at the proper time, inside the cylinder.

To do this, it is absolutely necessary that you use the proper amount of fuel that is free from water, and there is no obstruction to prevent its flow. Read very carefully the following paragraphs: Fuel, Clean Connections; Water in Fuel; Too Much Fuel and Too Little Fuel (pages 6 and 7).

The water valve be closed as instructed on page four, paragraph on how to stop Kerosene Engine.

The valves be properly timed: Read very carefully paragraph on Valve Timing (page 15),

The magneto furnished a spark: See pages 30 and 31, particularly paragraph one, page 31, and that it takes place at the proper time, see paragraph two, page 31.

The butter fly valve in air damper cage be properly adjusted. Turn the flywheels till the crank shaft is at outer dead center, and the cam roller is on low cam. Put the speed change lever No. 0157 in low speed, and with the left hand raise the throttle lever No. 0156 till the butter fly valve No. 170 in damper cage is wide open. This can be determined by the mark on this valve, as it must be in a horizontal position. With the right hand push the governor shaft arm No. 0154 tight against the end of the governor spindle rod No. 068 and in this position tighten the set screw on the governor shaft.

### FUEL, CLEAN CONNECTIONS.

Make certain there is plenty of fuel in tank.

See if the fuel flows to the mixing valve. Dirt sometimes gets into fuel pipe and collects on the fuel valve or under the check valve. Clean all connections carefully.

If you find the mixing valve or connections are dirty, drain the tank by removing the plug and strain the fuel through a chamois skin, which will keep out the dirt and water.

### WATER IN FUEL.

Water in fuel will cause loss of power. The presence of water is rather hard to detect, but if doubtful you can make certain by straining the fuel through a chamois skin. This is rather dangerous, however, as the gasoline, being a volatile substance, in passing through the chamois forms static-electricity, which will cause spark unless the funnel fits securely on a conducting material which is properly grounded; in other words, if the funnel fits securely on the mouth of the tank which is properly grounded on engine, you will need fear no danger from this source.

### TOO MUCH FUEL.

It is a common mistake to flood the cylinder in starting engine, which makes it very hard to start. Unless engine is subjected to a low temperature, do not flood the cylinder, as engine can be choked down by feeding too much fuel just as easily as by not feeding enough. If fuel is subjected to low temperature, the rate of vaporization is much lower and an extra amount of fuel is necessary.

### TOO LITTLE FUEL.

If engine is not given the proper amount of fuel there will be a popping and back-firing out of air inlet; however, this popping noise is also caused by poor ignition, valves not seating properly, or poor mixture. It is possible that the head gasket has given out, allowing water to leak out and mix with the fuel; if so, it will be necessary to replace with a new gasket. Generally, the leak is so slight that after engine has once been started the leak is not noticeable.

### IGNITION.

Be sure the battery or magneto wires are properly attached, in good condition, and that a bare wire does not touch any part of the engine except the binding post.

Test the batteries by snapping the two wires together when the switch is closed to see if they give a good spark.

**Make certain that the movable electrode works freely; if not, it is evident that this is gummed up or corroded, and will have to be removed and cleaned with kerosene.**

### IF ENGINE DIES DOWN AFTER STARTING.

#### LACK OF FUEL.

See that there is proper amount of fuel in tank.

#### WEAK BATTERIES.

Test the batteries, testing each cell separately and replace worn out cells.

#### FAULTY IGNITION.

Examine the movable electrode in igniter; if this does not work freely, it is probable that it is corroded or gummed up, and the heat generated in starting engine caused this to bind. If this is cause of trouble, remove the electrode and clean thoroughly with kerosene.

If engine is magneto equipped, see that the No. 585 screw (page 27) is fastened securely in counter-seat in cam rod and that the No. 325 push rod (page 27) is set properly, as is fully explained on page 31. If battery equipped engine, make certain that the No. 047 set screw (page 20) is fastened securely in counter-seat in cam rod.

It is possible that the No. 051 trip blade (page 20) has worn, causing engine to fire late; if so, this blade can easily be regulated, as explained in the instruction book, and you should have no trouble whatever in adjusting the igniter so that it sparks properly at all times.

### IF ENGINE HAS NO POWER.

#### SPARK REGULATION.

If magneto equipped, have you advanced spark; that is, have you placed timing lever "J" back in running position after you have started engine?

#### FAULTY IGNITION.

Make certain that the igniter trips when the word "spark", which you will find stamped on the rim of the fly wheel, is opposite top of cam rod.

If magneto equipped, notice the setting of the No. 358 adjusting screw (page 27). The adjustment of this has been explained above, and you should have no trouble in regulating this part of magneto.

Make certain that the movable electrode works freely. If this binds whatsoever, remove same and clean with kerosene, as explained above.

## KEROSENE OR GASOLINE ENGINE INSTRUCTIONS— Continued.

### POOR MIXTURE.

The greater percentage of causes of lack of power can be traced down to a poor mixture. If the charge is not mixed properly, it makes a slow burning mixture which will, in most cases, cause back firing, owing to the charge burning so slowly that it fires the incoming charge, which, of course, would naturally escape back through the mixer on account of inlet valve being open.

Owing to the variance in atmospheric conditions, there is no certain point at which the needle valve may be adjusted; however, if you will carefully watch action of engine and adjust it at a point at which the engine runs most regularly, and without excessive exhaust, you will have no trouble along this line.

If you are using kerosene oil, make certain that you are feeding the proper amount of water to carburetor. Too much water will cut down the power; too little water makes a poor mixture, which burns slowly, resulting in late combustion, which besides causing a loss of power, and leaving an excessive deposit of carbon on the cylinder wall, heats up the engine to such an extent that a pounding results, commonly called preignition. This pounding can always be nearly eliminated by feeding a little water to carburetor. Preignition is indicated by a deep, heavy sound and is generally either caused by a poor mixture, hot cylinder or a red hot deposit in cylinder.

If preignition does not seem to be due to poor mixture or a hot cylinder, it is evidently due to an excessive deposit of carbon in the combustion chamber. However this trouble can generally be eliminated by running engine a short time on denatured alcohol; if this does not eliminate the trouble, remove the head and clean combustion chamber thoroughly.

Test fuel for water. Water in fuel will cause loss of power. See page 6.

Make certain that the exhaust valve is closing on inner center. See page 15.

If valves do not seat properly, remove same and grind them down so that they fit the valve seats properly. This adjustment is fully explained on page 15.

### MISCELLANEOUS.

Make certain that the working parts, such as gears, governor, etc., are properly oiled. It is well to examine the oil tube in piston from time to time and make sure that this is not clogged up.

In cold weather, much attention must be paid to lubrication. If the oil is subjected to low temperature it will have a tendency to thicken to such an extent that it will not flow freely down oil pipe. In such cases, it is well to warm the oil before starting.

Oil the governor so that it works freely; also feed the proper amount of oil to oil hole in cam and to the pocket in governor bracket through which cam rod works.

If after going over the adjustment of each part according to the instructions in this book, you cannot get the engine to run satisfactorily, write us a letter. Tell us just what you have done, just how the engine acts, and we will tell you by return mail just what to do.

If in writing you refer to any certain part, give the regular repair list number of same so we will know exactly what you are referring to.

## BATTERY IGNITION INSTRUCTIONS.

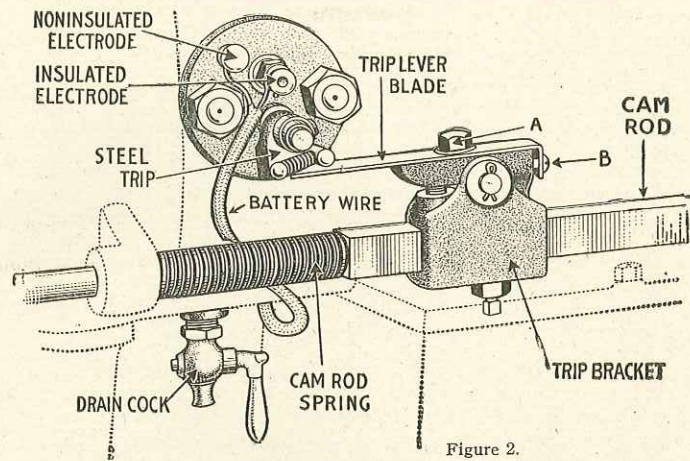

THE IGNITER.

The igniter is located on the side of the cylinder, as shown above, and is used to make the spark inside of the cylinder. Two wires from the battery (or one from the magneto) are attached to the brass binding posts on the igniter.

The trip on the igniter is caught by the trip lever blade on the cam rod, which brings two points together on the inside of the cylinder, and when these points are released the spark jumps from one point to the other, which is known as the make and break system of ignition. In other words, you make the circuit complete when the igniter points are together, and when they separate it breaks the circuit and makes a spark.

### KEEP THE IGNITER CLEAN.

To insure a good spark from these points, they must be kept clean. If you feed too much gasoline or oil or use a poor grade of either, a deposit may form on these points, which will prevent the points from making a good contact and the igniter cannot give a perfect spark, making the engine hard to start or causing it to misfire and sometimes preventing it from running at all. To remove this deposit, clean the points with gasoline, fine emery cloth or a very fine file.

In order that the spark shall occur inside of the cylinder, the insulated electrode is covered by a mica tube with mica washers on the end, so the electric current must go into the cylinder before it can get across to the other electrode and return to the battery.

As electricity always travels the shortest way, the igniter should be kept clean and free from grease, dust or dirt, as these will in time make a path for the electricity to travel from the insulated electrode to the non-insulated electrode on the outside of the engine, so that you do not get a spark at the igniter points. This is what is known as a short circuit.

To test the igniter, take it off the engine, leaving the battery wires attached to the binding posts and snap the igniter by hand. If there is no spark at the

points when they separate, and you know the battery is all right, the igniter is short circuited and will have to be taken apart and cleaned. When taking the igniter apart be sure to notice just how each part is fitted, so you can put it together again properly. In cleaning the parts use kerosene or gasoline, and it may be necessary for you to get a new mica tube and washers. (See No. 032 and No. 033, page 20.)

Be careful in removing the igniter not to tear the packing or gasket, as you will need this when you replace the igniter. If you should tear it, don't put the torn one back on; buy a new one. (See No. 026, page 18.) When replacing the igniter, screw the nuts down with your fingers as far as possible, then tighten one nut at a time with the small wrench furnished with the engine. Give each nut one-half turn at a time until they are tight, as this draws the packing down evenly all the way around and prevents a leak. **Be sure after replacing the igniter that the spark takes place at the right time.** (See page 11.)

If engine is equipped with magneto, see page 32.

### BATTERIES.

When replacing worn out dry cells be sure the new ones are wired up like the old set and that the spark coil is connected between the engine and the batteries, as the coil is what makes the spark.

We are not responsible for worn out batteries, as their life depends entirely on the care given them. **Buy a magneto for your engine and you never will need batteries.**

### HOW TO ADJUST THE GASOLINE FUEL VALVE.

The mixing valve (Figure 3) is of the suction feed type, gasoline being drawn from the tank in the base by the suction of the piston. The air and gasoline are mixed in this valve to form the explosive gas.

When you start the engine, open the fuel valve, close the air damper and turn the flywheel to the right; this draws a supply of gasoline from the tank and primes the valve. It is a common mistake to flood the cylinder in starting engine. Open fuel valve  $\frac{1}{2}$  turn on  $1\frac{1}{2}$  H. P. engine and from one to two turns on the larger sizes. In cold weather use more fuel. After the engine is running, open the air damper and close the fuel valve slowly until the point is reached where the engine runs with the least number of explosions and without black smoke appearing at the exhaust, or a popping sound at the mixer, the latter being caused by an insufficient supply of fuel, and smoke at the exhaust by too much fuel.

If it is ever necessary to take the mixing valve and feed pipe off the engine, be very careful not to lose the valve out of the check valve, because if this valve is not in place your engine will not get any gasoline. To drain gasoline from tank remove drain plug. (See Figure 3.)

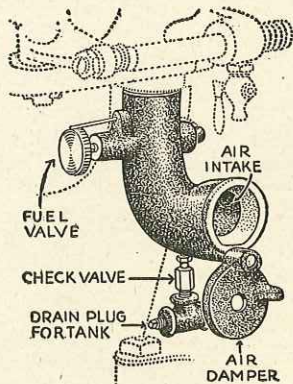

Figure 3.

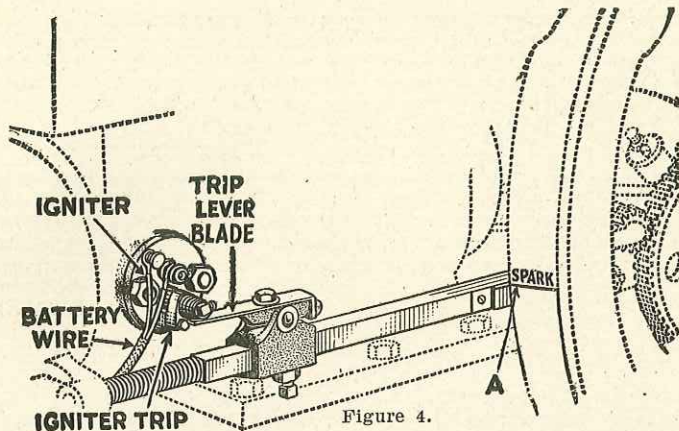

Figure 4.

### WHEN THE SPARK SHOULD TAKE PLACE.

The power of an engine is furnished by an explosion of gas inside the cylinder. This gas is made by fuel and air being drawn in through the mixing valve by the suction of the piston. To ignite this gas an electric spark is furnished by a battery or a magneto.

To get the most power from the engine the explosion should take place when the piston reaches the end of the compression stroke or is in the cylinder as far as it will go, so the piston will be pushed out of the cylinder with the full force of the explosion. To get this condition, it is necessary that the electric spark takes place at just the right time.

In order that you may know just where the spark should take place to give the best results we have stamped the word **Spark** on the rim of the flywheel. The spark should take place in the cylinder just as this word **Spark** on the flywheel around slowly by hand to the right and stop instantly when you hear the igniter snap. If the top of the cam rod is directly opposite the word **Spark** on the flywheel, then the spark takes place at the right time in the cylinder.

If the word **Spark** is below the top of the cam rod, then the spark takes place too soon; if the word **Spark** has passed the top of the cam rod, then the spark takes place too late.

To change the time of the spark, loosen the locknut "A," Figure 2, page 9, and adjust by changing the adjusting screw "B." To advance the spark, turn this screw to the right; to retard the spark turn it to the left. After you have the trip set so the spark occurs at the right time, tighten the locknut "A." Then turn the flywheels around again and see if the igniter snaps at the right time, as in tightening down the locknut it sometimes changes the point at which the spark takes place.

**If engine is magneto equipped, see page 31 for instructions as to setting of spark.**

The trouble you have with a gasoline engine is usually caused by the spark not taking place at the right time. If it occurs too late the engine loses power; if it occurs too early there is a back pressure, causing a pounding in the cylinder or preventing the engine from running at all.

## TO START IN COLD WEATHER.

All engines are harder to start during cold weather than in warm weather, because gasoline does not vaporize as readily in cold weather. You can overcome any difficulty from this cause in starting by pouring a couple of gallons of warm water in the water reservoir; this warms up the cylinder, causing the gasoline to vaporize more readily. (Be careful if engine is real cold not to use water too hot, as the sudden change may crack the cylinder.) It is also advisable to open the fuel valve farther than you generally do, and be sure to close the air damper when starting; also put a teaspoonful of gasoline in the cylinder through the priming cup if the engine has one. Work the intake valve in and out before starting in cold weather, as this will remove any frost that may have collected on the valve stem and allow valve to work easily.

## IF THE WATER IN THE HOPPER SHOULD BOIL.

The hotter the water gets the better the engine runs, because the gasoline vaporizes more readily and the engine will use less gasoline. The cylinder is cooled by the water circulating around it and the heat passes off in the form of steam, so if the water boils, you need not be alarmed. Keep the cylinder properly lubricated and the reservoir full of water and there will be no danger of your engine overheating. **IN COLD WEATHER DRAIN BOTH THE CYLINDER AND CYLINDER HEAD AT NIGHT TO PREVENT FREEZING.**

## HOW TO PUT ON THE CAM GEAR.

If it is ever necessary to take off the cam gear or to put on a new one it must be put on in a certain position, as the cam on the gear controls the time of the spark and the opening and closing of the valves, in fact every operation of the engine depends on this cam being set just right.

To put on the cam gear, hook detent blade back of catch block, turn the flywheels around until the key in the crank shaft is straight up, as shown by "B" in Figure 5; then set the two teeth that are just under the indicator "A" on the cam gear over the one tooth that is just above the Key "B"; then roll the cam gear around to the right until it reaches the position as shown by dotted gear, being sure to keep the gear teeth together. Then slip the cam gear pin in place and fasten it with the lock washer and nut.

Be very careful in putting on this gear to see that it is just right. One tooth out of the way makes a decided difference in the way your engine will run.

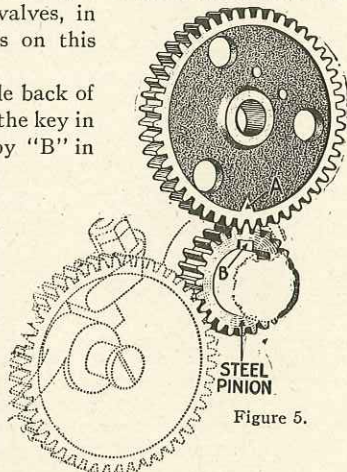

Figure 5.

## THE GOVERNOR.

### FOR GASOLINE ENGINE.

The governor controls the speed of the engine and is of the ball type. When the engine runs above its regular speed, the balls on the governor widen their circuit, which presses in on the pin going through the governor spindle. This forces the detent blade in so that it catches behind the block on the cam rod and holds the exhaust valve open, at the same time stopping the spark and cutting off the supply of fuel, until the speed of the engine is reduced to where it should be, then the detent blade flies out again, releasing the cam rod and the engine takes up its regular operations. **When running, empty the engine exhausts every eight to ten revolutions of the flywheel.**

### FOR KEROSENE ENGINE.

The throttling governor engine is also designed with the ball type governor.

It is very sensitive and acts directly on a butterfly valve in the fuel passage going to the cylinder head, which regulates the amount of fuel and air admitted to the cylinder in proportion to the load on the engine, maintaining constant speed with the least fuel consumption under all conditions. When running empty or on a load this type engine exhausts every second revolution of the flywheels.

Always make certain that cam rod does not bind and works freely through pocket in governor bracket.

Always keep the speed lever set at high speed, as this runs the engine at its regular speed, where it will give its full power. If you reduce the speed of the engine you also reduce the power it will develop. Never slow the engine down on a heavy load. If you want less speed for heavy work get a smaller pulley.

By means of the speed regulator you may slow your engine down about 100 R. P. M. (See page 33 for rules for determining the size of pulleys to use.)

## TO TAKE OFF THE GOVERNOR BALLS, SPINDLE OR PINION.

If you find it necessary to take the governor apart, first take off the governor pinion. To do this hold the flywheels stationary, which locks the gears, then take a wrench, stand on the governor side of the engine and turn the governor balls to the right, as the pinion is put on with a right hand thread. The governor spindle screws into the governor pinion.

## HOW TO ADJUST THE DETENT BLADE.

When the exhaust valve is wide open and the detent blade is pushed in behind the catch block on the cam rod, there should be only the thickness of a postal card between them. When adjusting the detent blade, the speed lever should be set at lowest speed and the detent blade should stand about  $\frac{1}{16}$  inch away from the catch block.

To adjust the detent blade loosen the locknut "A" and screw the adjusting screw "B," either in or out, until you have the blade where it should be, then tighten the locknut.

**There is no detent blade on throttling governor kerosene engine.**



## THE DETENT CATCH BLOCK.

The catch block on the cam rod is made of tool steel and should last a long time. If the block should wear on one side so it does not hold the detent blade properly, file off the point of screw where it is riveted on side of rod next to the engine, remove the screw with a screwdriver and turn the catch block around, using the other side. After both sides of the block are worn, buy a new one. (See No. 054 in list of repairs, page 22.)

**There is no catch block used on throttling governor kerosene engine.**

## THE CAM ROD SPRING.

The cam rod spring (see Figure 2, page 9) holds the cam rod and roller against the cam on the cam gear. As this spring does a lot of work it may wear out; if it does, buy a new one. (See No. 059 in list of repairs, page 22.) To put on a new spring, remove the cylinder head, slip the spring over the end of the cam rod and replace the cylinder head. If necessary to repack cylinder head, see page 16.

## HOW TO TAKE OFF A FLYWHEEL OR PULLEY.

To take off the flywheel, loosen the bolt and drive iron or wooden wedges into the slot, one on each side of the hub. This will loosen the flywheel so it can be removed. To take off the pulley on the 1½-horse power engine loosen the set screw with a screwdriver and drive the pulley off.

On the larger engines all you have to do is loosen the nuts, take out the bolts or cap screws and the pulley will come off.

If you have to drive the flywheel or pulley off the shaft, use a piece of hard wood against the hub of the wheel and do not drive too hard. A number of light blows will loosen the flywheel without danger of breaking.

To remove the friction clutch pulleys, see page 26.

## HOW TO REPLACE A FLYWHEEL.

When replacing flywheel, place wheel in proper position on shaft, tighten the bolts down securely and drive in key.

To replace the friction clutch pulleys, see page 26.

## VALVES.

The inlet valve "A," as shown in the illustration, is opened by the suction of the piston. For the entire length of the suction stroke gas is being drawn into the cylinder; then when the piston starts to compress the gas this valve closes and is held shut by the valve lock "C," so that no gasoline is wasted.

If there is a loss of fuel at the opening of the mixer loosen the lock nut on the valve lock stud "C" and screw stud out one turn and tighten locknut. If engine does not get enough fuel loosen locknut as above and screw stud in one turn and tighten locknut.

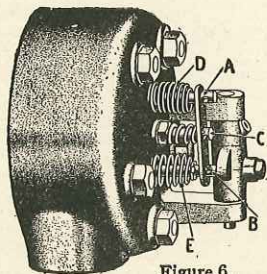

Figure 6.

## VALVES—Continued.

### VALVE TIMING.

In many cases where engine is hard to start, trouble can be traced to the valves not being timed properly.

As this is a four cycle engine, we will show you the four distinct parts in the movement of the piston and crankshaft and the timing of the valves.

The first is known as the suction stroke, during which time the piston is traveling from extreme inner to extreme outer position, causing a vacuum which automatically opens the inlet valve and admits a charge of kerosene mixed with air from the carburetor.

In the next, or compression stroke, the piston returns from extreme outer to extreme inner position, compressing the charge which has been drawn into the cylinder. During this stroke both valves remain closed. The spark taking place just before the end of this stroke.

The third, or power stroke, is caused by the force of the explosion in the cylinder driving the piston out again to its outer position. Before the piston reaches the extreme outer position the exhaust valve is opened by means of a cam which pushes out the cam rod and works the valve lever and lifts the valve. The proper time for this valve to start to lift is when the crankshaft is half way between the vertical and horizontal position on the downward part of this stroke.

We now come to the last or exhaust stroke. The exhaust is already open so as the piston returns from its outer position it drives the burnt gases out into the exhaust pipe. The exhaust valve remains open until the crankshafts have passed the inner center 3° or 5°.

This adjustment is controlled by means of No. 06 adjustment screw (page 18), and is easily regulated.

Notice the setting of this valve from time to time, as this may work out of adjustment as the engine is used.

If exhaust valve spring has weakened to such an extent that suction is pulling in exhaust valve, replace with new spring.

When cam rod is not in contact with No. 06 adjusting screw, the No. 24 valve lock lever should not bind on either valve stem. This can be easily regulated by readjusting the "C" valve lock stud. See illustration on opposite page.

## HOW TO GRIND THE VALVES.

When an inlet or exhaust valve leaks, remove the cylinder head, take off the valve springs, remove the valve you want to grind and wash it and the valve seat in gasoline, then make a paste of fine emery dust and oil. If you cannot get emery dust, use powdered pumice stone with oil. (You can get powdered pumice stone at almost any drug store.) Smear this on the valve and valve seat, put the valve in place and put a nail through the hole in valve stem on the outside of the head, grasp the nail with your fingers and turn from left to right for a minute or so, then lift the valve and turn it about half way around and repeat this until the valve and valve seat show an even surface all the way around.

After the valve is ground in, wash off the emery dust with gasoline and do not get any dirt on the valve seat. In replacing the valves be sure to get the heavy spring on the exhaust valve and the light spring on the inlet valve.

## PACKING THE CYLINDER HEAD.

We use a special graphite asbestos packing between the cylinder and cylinder head to prevent the escape of the compressed gas.

To repack the cylinder head in case the packing should blow out or if you should break the packing when removing the cylinder head, you can use ordinary asbestos packing such as you buy at your hardware store or the kind we furnish under No. 17 on page 18. If you use the ordinary asbestos packing, soak it in linseed oil; if you buy our special graphite asbestos packing or gasket, it is all ready to be put on.

Before putting on new packing be sure all particles from the old packing which may have stuck to the cylinder or cylinder head are scraped off and that these parts show a smooth, clean surface. If all the old particles are not cleaned off the new packing will blow out in a short time.

After you have the packing in place push the cylinder head in close to the cylinder and screw on the nuts by hand as far as they will go, then use a wrench and turn each nut, one after the other, about one-half turn at a time. **Do not screw one nut down perfectly tight and then go to the next, as this causes an uneven joint and the packing will not hold.** After the engine has been running for about ten minutes tighten the nuts again and you will have a perfectly tight joint.

If you make a new packing from sheet asbestos you must be sure to cut openings in the packing so the water can circulate from the cylinder, through the cylinder head and around the valves; if you fail to cut these water openings the cylinder head will get too hot and be ruined.

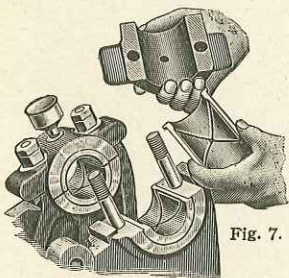

Fig. 7.

The Main Bearings.

## BEARINGS.

Be sure all bearings are kept properly adjusted. An engine should never be run with a bearing that is too loose or too tight. A loose bearing will soon rack your engine and break something, and a tight bearing will heat up and soon melt.

The main bearings and crankshaft end of connecting rod have die cast bearings which fit perfectly into the machined bearings. The piston end of the connecting rod has a cast bushing.

All the bearings can easily be replaced; the bearing in the piston end of the connecting rod can be driven out and a new one driven in.

The crankshaft bearings and the bearing in the crankshaft end of the connecting rod are made of a special die cast babbitt. They are fitted with steel liners so you can take up any wear in the bearings. Remove the bearing cap and take out enough of the steel strips from both sides of the bearing so it fits snug.

After you have removed the steel strips and put the cap back on again, screw down the bolts, but before starting the engine open the exhaust valve by pushing the detent blade in behind the catch block on the cam rod and turn the flywheels around by hand to see that they turn freely. If they bind you have taken out too many steel strips and you will have to put enough back until the flywheels turn easily. Watch the grease cups closely and give them a quarter of a turn each time you start the engine. See that all bolts are tight and you will have no trouble with the bearings.

## PISTON AND RINGS.

As explained on page 4, what makes the engine run is the combination of air and gas drawn into the cylinder by the suction of the piston, this gas being compressed before it is exploded. To compress this gas it is necessary that the space in the cylinder be gastight. The piston is fitted to the cylinder and makes a fairly tight joint, but on account of the expansion of iron when it gets hot, it is necessary to have some other means of keeping the gas from escaping. Each piston is fitted with three rings that spring out and press against the walls of the cylinder, preventing the gas from escaping.

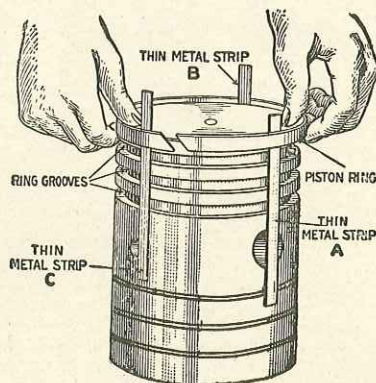

Figure 8.

These piston rings hold the compression and must fit free in the grooves of the piston. Feeding a poor grade of gasoline or lubricating oil, or too much of either, will cause a carbon deposit to form around the rings, which will in time bind them in the grooves, so they cannot spring out against the walls of the cylinder to hold the compression. It is very necessary that you use the proper grade of oil and watch the supply of gasoline, for on this depends the proper running of the engine.

Before removing the piston from the cylinder, be sure the wire is disconnected from the batteries or magneto, take out the connecting rod bolts at the crankshaft end of the connecting rod. Remove the bearing which loosens the connecting rod from the crankshaft. Next, you will have to take off the governor spindle, as instructed on page 13, which gets the spindle and balls out of the way. This is all of the governor that you will have to take off, as the piston will now slip out of the cylinder.

If you find the piston rings are gummed or held tight in the grooves, they must be thoroughly cleaned. To do this you will have to remove the rings and wash them in kerosene or gasoline and you may have to scrape them with a knife.

To remove the rings take three thin metal strips (pieces of an old hack saw blade are fine for this) and slip under the center ring. Start the first strip under the ring at the joint and force it all the way around until you have it at the position shown by "A," Figure 10, then slip the second strip to "B" and the third to "C," which will raise the ring out of the groove so it can be slipped off. Take the top ring next and repeat the operation; then the bottom ring.

In replacing the rings, put the center ring on first, using the three metal strips as before, then without the three metal strips you can slip the top ring on and then put the bottom ring on, bringing it up from the bottom of the piston. Before putting the piston back in the cylinder, oil the rings and surface of the piston thoroughly.

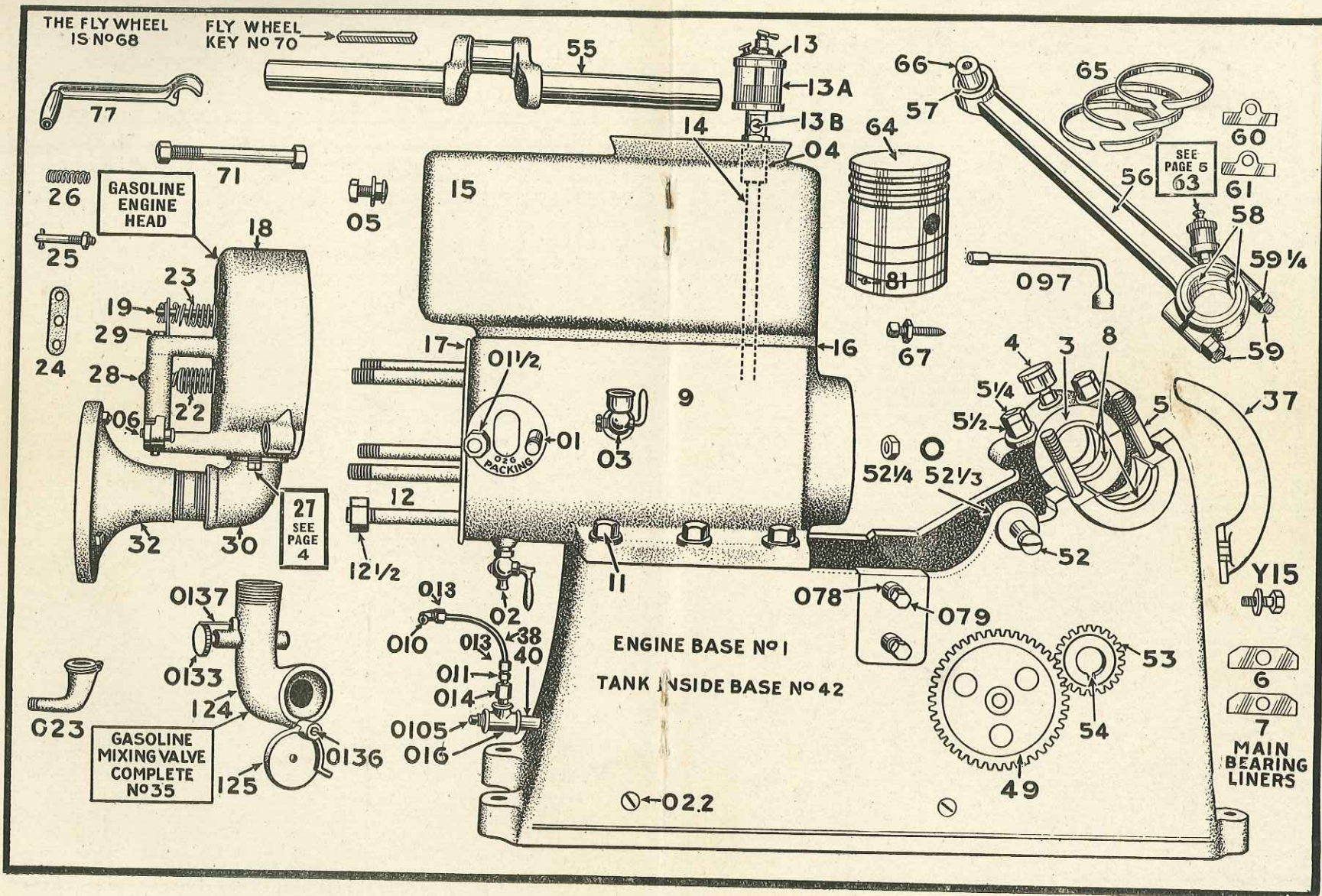

# Kerosene Engine Head and Carburetor Complete.

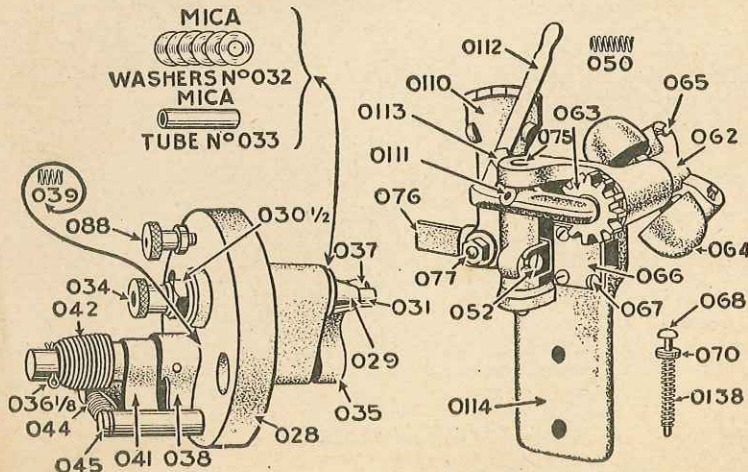
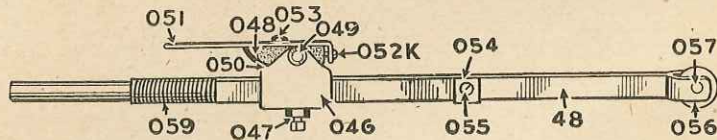
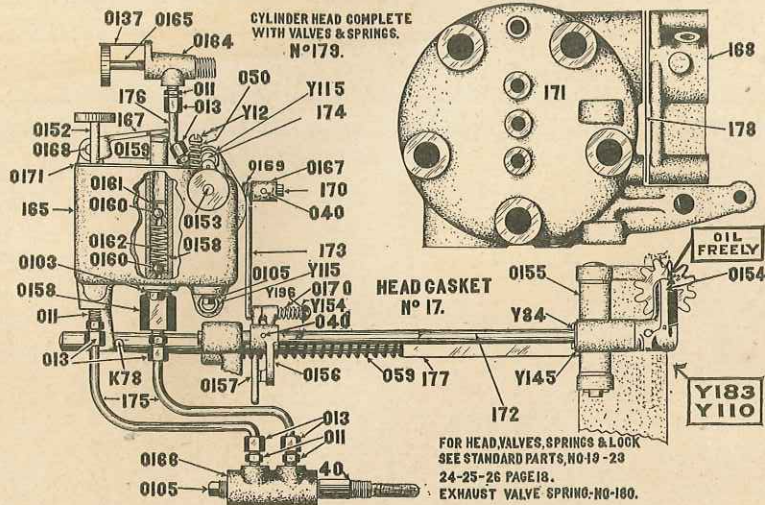

Gasoline Engine Governor Complete.

# PRICE LIST OF ENGINE PARTS.

When Ordering Parts, Be Sure to Give the Letters, Number and Horse Power of Your Engine as Stamped on Name Plate.

See Illustration on Page 31.

Part No.	Description	Horse Power					
		1½	3	5	7	9	12
Y12	*Screw.....		\$0.05	\$0.05	\$0.05	\$0.05	\$0.05
K78	*Pump Drive Pin.....		.05	.05	.05	.05	.05
Y80	*Cotter Pin.....		.04	.04	.04	.04	.04
Y84	*Cotter Pin.....		.05	.05	.05	.05	.05
Y110	Locknut.....		.05	.05	.05	.05	.05
Y115	*Nut.....		.06	.06	.06	.06	.06
Y145	*Washer.....		.04	.04	.04	.04	.04
Y183	*Gov. Shaft Arm Set Screw.....		.05	.05	.05	.05	.05
040	*Taper Pin.....		.05	.05	.05	.05	.05
0103	*Pipe Plug.....		.05	.05	.05	.05	.05
0152	*Drain Valve.....		.18	.18	.18	.18	.18
0153	*Fuel Valve.....		.15	.15	.15	.15	.15
0154	*Governor Shaft Arm.....		.25	.25	.25	.25	.25
0155	*Governor Shaft Bearing.....		.25	.25	.25	.25	.25
0156	*Throttle Lever.....		.25	.25	.25	.25	.25
0157	*Speed Changing Lever.....		.09	.09	.09	.09	.09
0158	*Pump Body.....		.95	.95	.95	.95	.95
0159	*Pump Plunger.....		.20	.20	.20	.20	.20
0160	*Check Ball.....		.05	.05	.05	.05	.05
0161	*Check Ball Retainer Pin.....		.05	.05	.05	.05	.05
0162	*Pump Spring.....		.06	.06	.06	.06	.06
0164	*Water Valve Seat.....		.25	.25	.25	.25	.25
0165	*Water Valve.....		.15	.15	.15	.15	.15
0166	*Fuel Valve Tee.....		.25	.25	.25	.25	.25
0167	*Damper Lever.....		.08	.08	.08	.08	.08
0168	*Pump Lever Pin.....		.05	.05	.05	.05	.05
0169	*Damper Spring.....		.05	.05	.05	.05	.05
0170	*Speed Change Lever Spring.....		.05	.05	.05	.05	.05
0171	*Carburetor Lid.....		.10	.10	.10	.10	.10
165	*Carburetor Body.....		2.30	2.30	2.65	2.65	2.95
165A	*Kerosene Carburetor, Complete.....		4.00	4.00	4.35	4.35	4.50
166	*Nozzle Tube.....		.05	.05	.06	.06	.06
167	*Pump Lever.....		.55	.55	.60	.60	.60
168	*Air Damper Cage, with damper and stem.....		1.05	1.05	1.35	1.35	1.60
171	xCylinder Head.....		2.25	3.35	4.20	5.45	6.55
172	*Governor Shaft.....		.25	.30	.35	.40	.45
173	*Air Damper Rod.....		.18	.18	.20	.20	.20
174	*Carburetor Stud.....		.19	.19	.20	.20	.20
175	*Fuel or Drain Pipe.....		.35	.40	.45	.55	.70
176	*Water Pipe.....		.10	.10	.12	.15	.15
177	*Cam Rod.....		.95	1.10	1.25	1.45	1.70
178	*Air Damper Cage Gasket.....		.20	.20	.20	.20	.20
179	Kerosene Cylinder Head, Complete.....		4.40	5.45	6.75	8.15	10.30
180	*Exhaust Valve Spring (Kerosene Engine).....		.10	.10	.15	.15	.15
184	*Intake Valve Spring (Kerosene Engine).....		.10	.10	.15	.15	.15

NOTE—All items marked (\*) will be shipped by parcel post, postage paid. All items marked (x) will be shipped by express or freight, collect.

**PRICE LIST OF ENGINE PARTS.  
SUBJECT TO CHANGE WITHOUT NOTICE.**

**When Ordering Parts, Be Sure to Give the Letters, Number and Horse Power of Your Engine as Stamped on Name Plate.**

Part No.	Description	Horse Power					
		1½	3	5	7	9	12
01	*Igniter Stud.....	\$0.08	\$0.08	\$0.08	\$0.08	\$0.08	\$0.08
01½	*Igniter Stud Nut.....	.06	.06	.06	.06	.06	.06
02	*Drain Cock.....	.35	.35	.35	.35	.35	.35
03	*Priming Cup.....	.35	.35	.35	.35	.35	.35
04	*Oil Pipe Coupling.....	.10	.10	.10	.10	.10	.10
05	*Water Reservoir Bolt.....	.10	.10	.10	.10	.10	.10
06	*Valve Lever Adjusting Screw.....	.10	.10	.10	.10	.10	.10
010	*Angle Connection.....	.20	.20	.20	.20	.20	.20
011	*Straight Connection.....	.25	.25	.25	.25	.25	.25
013	*Pipe Union and Coupling.....	.25	.25	.25	.25	.25	.25
014	*Straight Valve Cage & Check Valve.....	.40	.40	.40	.40	.40	.40
016	*Pipe Tee.....	.15	.15	.15	.15	.15	.15
022	*Tank Rod.....	.15	.25	.25	.25	.30	.30
023	*Filler Pipe.....	.25	.25	.25	.25	.25	.25
026	*Igniter Gasket.....	.10	.10	.10	.10	.10	.10
027	*Igniter, complete.....	2.50	3.00	3.00	3.00	3.00	3.00
028	*Igniter Body.....	.35	.50	.50	.50	.50	.50
029	*Stationary Electrode.....	.15	.15	.15	.15	.15	.15
030½	*Stationary Electrode Nut.....	.05	.05	.05	.05	.05	.05
031	*Stationary Electrode Point.....	.08	.08	.08	.08	.08	.08
032	*Insulating Washers (set).....	.06	.08	.08	.08	.08	.08
033	*Insulating Tube.....	.10	.10	.10	.10	.10	.10
034	*Binding Nut.....	.10	.10	.10	.10	.10	.10
035	*Movable Electrode.....	.25	.30	.30	.30	.30	.30
036½	*Cotter Pin.....	.05	.05	.05	.05	.05	.05
037	*Movable Electrode Point.....	.08	.08	.08	.08	.08	.08
038	*Igniter Anvil.....	.15	.15	.15	.15	.15	.15
039	*Igniter Anvil Seating Spring.....	.08	.08	.08	.08	.08	.08
041	*Igniter Trip.....	.30	.30	.30	.30	.30	.30
042	*Igniter Tension Spring.....	.08	.08	.08	.08	.08	.08
044	*Igniter Trip Spring.....	.08	.08	.08	.08	.08	.08
045	*Igniter Stop Pin.....	.05	.05	.05	.05	.05	.05
046	*Igniter Trip Bracket.....	.35	.50	.50	.50	.50	.50
047	*Set Screw and Locknut.....	.10	.10	.10	.10	.10	.10
048	*Igniter Trip Lever.....	.15	.30	.30	.30	.30	.30
049	*Igniter Trip Lever Pin with Cotter Pin.....	.08	.08	.08	.08	.08	.08
050	*Igniter Trip Lever Spring.....	.08	.08	.08	.08	.08	.08
051	*Igniter Trip Lever Blade.....	.10	.10	.10	.10	.10	.10
052	*Detent Blade Adjusting Screw.....	.08	.08	.08	.08	.08	.08
052K	*Trip Lever Adjusting Screw.....	.08	.08	.08	.08	.08	.08
053	*Igniter Trip Blade Locknut.....	.06	.06	.06	.06	.06	.06
054	*Detent Catch Block.....	.15	.20	.20	.20	.20	.20
055	*Catch Block Screw.....	.05	.05	.05	.05	.05	.05
056	*Cam Roller.....	.15	.20	.20	.20	.20	.20
057	*Cam Roller Pin.....	.10	.10	.10	.10	.10	.10
058	*Cam Roller Pin Dowel.....	.06	.06	.06	.06	.06	.06
059	*Cam Rod Spring.....	.08	.08	.08	.08	.08	.08
060	*Governor, complete.....	3.50	4.00	4.00	4.00	4.00	4.00
062	*Governor Spindle.....	.40	.50	.50	.50	.50	.50
063	*Governor Pinion.....	.35	.35	.35	.35	.35	.35
064	*Governor Ball.....	.15	.15	.15	.15	.15	.15
065	*Governor Weight Pin with Cotter Pin.....	.06	.08	.08	.08	.08	.08
066	*Governor Bracket Plate.....	.10	.10	.10	.10	.10	.10
067	*Bracket Plate Screw.....	.06	.06	.06	.06	.06	.06
068	*Governor Spindle Rod.....	.20	.25	.25	.25	.25	.25
070	*Speed Changing Washer.....	.05	.05	.05	.05	.05	.05
075	*Detent Lever Pin.....	.08	.08	.08	.08	.08	.08
076	*Detent Blade.....	.10	.10	.10	.10	.10	.10

NOTE—All items marked (\*) will be shipped by parcel post, postage paid.

**PRICE LIST OF ENGINE PARTS.**

**SUBJECT TO CHANGE WITHOUT NOTICE.**

**When Ordering Parts, Be Sure to Give the Letters, Number and Horse Power of Your Engine as Stamped on Name Plate.**

Part No.	Description	Horse Power					
		1½	3	5	7	9	12
077	*Detent Locknut, complete.....	\$0.10	\$0.10	\$0.10	\$0.10	\$0.10	\$0.10
078	*Governor Bracket Dowels.....	.06	.06	.06	.06	.06	.06
079	*Cap Screws.....	.06	.08	.08	.08	.08	.08
088	*Binding Screw.....	.10	.10	.10	.10	.10	.10
090	xDry Cell Battery.....	.25	.25	.25	.25	.25	.25
091	*Coil and Switch.....	1.50	1.50	1.50	1.50	1.50	1.50
093	*Battery Wire with Terminals.....	.15	.15	.15	.15	.15	.15
094	*Battery Wire, short.....	.06	.06	.06	.06	.06	.06
097	*Igniter Wrench.....	.20	.20	.20	.20	.20	.20
0105	*¼-Inch Drain Plug.....	.10	.10	.10	.10	.10	.10
0110	*Speed Change Body.....	.25	.25	.25	.25	.25	.25
0111	*Detent Lever.....	.23	.25	.32	.35	.40	.45
0112	*Speed Change Lever.....	.05	.05	.05	.05	.05	.05
0113	*Speed Lever Screw.....	.05	.05	.05	.05	.05	.05
0114	*Governor Bracket.....	.50	.75	.75	.75	.75	.75
0130	*Air Damper Valve Spring.....	.15	.15	.15	.15	.15	.15
0133	*Fuel Valve.....	.25	.25	.25	.25	.25	.25
0136	*Damper Screw.....	.05	.05	.05	.05	.05	.05
0137	*Fuel Valve Spring.....	.05	.05	.05	.05	.05	.05
0138	*Governor Spindle Spring.....	.08	.08	.08	.08	.08	.08
0142	*Detent Spring.....	.06	.06	.06	.06	.06	.06
1	xBase (Stationary).....	7.50	6.50	10.00	18.50	32.50	45.00
2	xBase (Mounting).....				18.50	32.50	45.00
3	*Base Cap.....	.45	.65	.85	1.15	1.35	1.50
4	*Main Bearing Grease Cup.....	.25	.35	.40	.45	.50	.50
5	*Base Cap Stud.....	.15	.18	.18	.25	.25	.25
5¼	*Main Bearing Locknut.....	.06	.08	.08	.08	.08	.08
5½	*Main Bearing Stud Nut.....	.06	.08	.08	.08	.08	.08
6	*Bearing Liners, thick, per set.....	.10	.15	.15	.15	.15	.15
7	*Bearing Liners, thin, per set.....	.15	.15	.15	.15	.15	.15
8	*Main Bearings (2 halves).....	.75	.95	1.50	2.50	2.75	3.50
9	xCylinder.....	4.75	6.75	9.00	14.00	18.50	
11	*Cylinder Cap Screw.....	.08	.08	.12	.12	.12	.12
12	*Cylinder Head Stud.....	.20	.25	.30	.35	.35	.35
12½	*Cylinder Head Stud Nut.....	.06	.06	.08	.10	.12	.12
13	*Sight Feed Oiler, complete.....	1.25	1.35	1.35	1.50	1.75	1.75
13A	*Large Glass for Oiler.....	.30	.35	.40	.45	.50	.50
13B	*Small Glass for Oiler.....	.20	.20	.20	.20	.20	.20
14	*Oil Pipe.....	.18	.18	.20	.25	.25	.25
15	xWater Reservoir.....	1.95	2.75	3.50	4.50	6.25	
Y15	*Oil Guard Cap Screw with Washer.....	.08	.08	.08	.08	.08	.08
16	*Water Reservoir Gasket.....	.75	.80	.95	1.25	1.50	
17	*Cylinder Head Gasket.....	.35	.35	.50	.75	.95	
18A	xCylinder Head, complete with Valves, Springs, etc.....	3.00	4.25	5.25	6.50	7.80	9.90
18	xCylinder Head only.....	1.50	2.10	3.15	3.95	5.10	6.15
19	*Exhaust or Inlet Valve.....	.25	.30	.35	.40	.45	.50
22	*Exhaust Valve Spring.....	.10	.10	.10	.10	.10	.10
23	*Inlet Valve Spring.....	.10	.10	.10	.10	.10	.10
24	*Valve Lock Lever.....	.10	.10	.10	.15	.15	.15
25	*Valve Lock Stud.....	.10	.10	.10	.10	.10	.10
26	*Valve Lock Spring.....	.08	.08	.08	.08	.08	.08
27	*Pipe Plug.....	.06	.06	.06	.06	.06	.06
28	*Valve Lever.....	.30	.35	.40	.45	.50	.60

NOTE—All items marked (\*) will be shipped by parcel post, postage paid. All items marked (x) will be shipped by express or freight, collect.

**BE SURE TO GIVE NUMBER AND HORSE POWER OF YOUR ENGINE WHEN ORDERING PARTS.**

PRICE LIST OF ENGINE PARTS.

SUBJECT TO CHANGE WITHOUT NOTICE.

When Ordering Parts, Be Sure to Give the Letters, Number and Horse Power of Your Engine as Stamped on Name Plate.

Part No.	Description	Horse Power					
		1½	3	5	7	9	12
29	*Valve Lever Pin.....	\$0.08	\$0.10	\$0.10	\$0.10	\$0.16	\$0.16
30	*Street Elbow.....	.20	.22	.27	.35	.65	.95
31	*Muffler Nipple.....			See No. 32			
32	*Muffler, complete with Nipple....	1.25	1.85	2.25	2.65	3.15	4.25
33	*Muffler Cap.....	.50	.75	.90	1.10	1.35	1.45
35	*Gasoline Mixing Valve, complete..	2.00	2.15	2.65	2.90	3.40	3.65
37	*Oil Guard.....	.70	.90	1.00	1.10	1.50	1.70
38	*Supply Pipe and Connectors.....	.45	.45	.45	.45	.45	.45
40	*Strainer Nipple.....	.40	.40	.40	.40	.40	.40
42	*Fuel Tank.....	1.50	1.85	2.35	2.45	2.95	3.25
48	*Cam Rod.....	.80	.90	1.00	1.10	1.25	1.45
49	*Cam Gear.....	.95	1.10	1.15	1.50	1.65	1.75
52	*Cam Gear Stud.....	.10	.25	.30	.35	.40	.45
52 1/4	*Cam Gear Stud Nut.....	..	..	.08	.10	.10	.10
52 1/2	*Cam Gear Lock Washer.....	..	..	.06	.06	.06	.06
53	*Crankshaft Pinion.....	.50	1.80	2.15	2.45	2.50	2.75
54	*Crankshaft Pinion Key.....	.06	.08	.08	.08	.08	.08
55	xCrankshaft.....	3.00	4.35	6.50	8.50	10.75	15.00
56	Connecting Rod.....	*1.50	*2.75	x3.25	x4.25	x5.00	x6.25
57	*Connecting Rod Bushing.....	.20	.25	.30	.35	.40	.45
58	*Connecting Rod Bearing (2 halves)	.65	.75	1.15	1.50	1.85	2.50
59	*Connecting Rod Bolt with Cotter Pin.....	.30	.30	.30	.40	.45	.50
59 1/4	*Connecting Rod Nut.....	.06	.06	.06	.08	.08	.08
60	*Connecting Rod Liners, thick, per set.....	.10	.15	.15	.15	.15	.15
61	*Connecting Rod Liners, thin, per set.....	..	.15	.15	.15	.15	.15
63	*Connecting Rod Grease Cup.....	.25	.30	.35	.40	.45	.45
64	Piston.....	*1.25	*1.70	*2.10	x2.50	x3.25	x4.00
65	*Piston Ring (each).....	.25	.30	.40	.45	.50	.65
66	*Piston Pin.....	.35	.40	.45	.50	.75	1.15
67	*Piston Pin Set Screw, complete....	.06	.06	.08	.08	.10	.10
68	xFlywheel (each).....	2.75	5.50	10.00	15.75	25.00	32.50
70	*Flywheel Key.....	.08	.08	.10	.10	.10	.15
71	*Flywheel Bolt.....	.20	.20	.20	.25	.25	.25
77	*Starting Crank.....	.40	.40	.50	.50	..	..
79	*Machine Bolt for Pulley.....	..	.08	.10	.10	.15	.15
80	*Pulley Stud with Nut.....	..	.12	.12	.12	.14	.16
80	*Pulley Set Screw on 1½-H. P.....	.10	..	..	..	..	..
81	*Piston Oil Tube.....	.35	.35	.35	.35	.35	.35
84	xMounting Engine Fuel Tank.....	..	..	4.75	5.50	5.50	5.50
89	*Mounting Tank Binders.....	..	..	.35	.40	.40	.40
124	*Mixing Valve Body.....	.60	.60	.60	.75	.75	.75
125	*Mixing Valve Damper.....	.14	.14	.14	.17	.17	.17

NOTE—All items marked (\*) will be shipped by parcel post, postage paid. All items marked (x) will be shipped by express or freight, collect.

BE SURE TO GIVE NUMBER AND HORSE POWER OF YOUR ENGINE WHEN ORDERING PARTS.

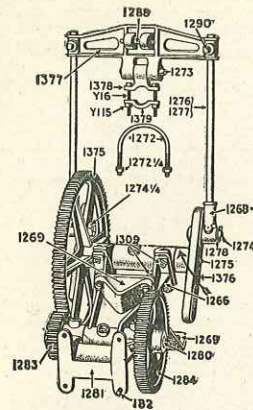

Single Gear Belt Driven Pump Jack Parts.

Part No.	Description	Price
J1	*Sub Base.....	\$0.90
J2	*Main Base.....	1.65
J3	*Cross Head.....	.85
J4	*Crank Arm.....	1.15
J5	*Large Gear and Shaft.....	1.35
J6	*Small Gear and Shaft.....	1.00
J7	*Tight Pulley with Set Screw.....	1.35
J8	*Loose Pulley.....	1.35
J9	*Clamp.....	.95
J10	*Crank Pin and Nut.....	.50

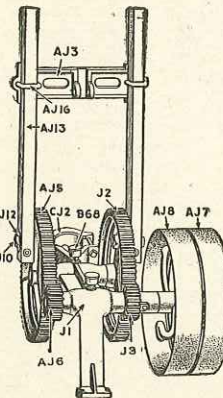

Direct Connected Vertical and Horizontal Pump Jack Parts.

Part No.	Description	Price
182	*Cap Screw.....	\$0.10
1266	*Pump Gear Bearing and Bracket. Weight, 12 lbs..	1.15
1268	*Pump Rod Head with Pin.....	.50
1269	*Stand.....	.90
1272	*Vertical Pump Clamp.....	.06
1272 1/4	*Nut for Clamp.....	.05
1273	*Pump Lever Pin.....	.06
1274	*Pump Rod Stud.....	.15
1274 1/4	*Nut for No. 1274.....	.35
1275	*Large Pump Gear Shaft.....	.08
1276	*Horizontal Short Pump Rod.....	.75
1277	*Vertical Long Pump Rod.....	.75
1278	*Washer for Pump Rod Stud.....	.05
1280	*Small Gear Shaft.....	.60
1281	*Engine End Bracket.....	1.50
1283	*Pinion with Pin.....	.95
1284	*Gear with Pin. Weight, 10 pounds.....	1.45
1288	*Vertical Pump Rod Pin.....	.20
1290	*Set Screws.....	.05
1309	*Bolt for Stand.....	.06
1375	*Crank Gear with Pin. Weight, 17 pounds.....	2.10
1377	*Bell Crank with Pin.....	.95
1377	*Crosshead.....	1.35
1378	*Pump Handle Clamp.....	.50
1379	*Clamp Cap.....	.25
Y16	*Cap Screw.....	.10
Y115	*Nut.....	.05

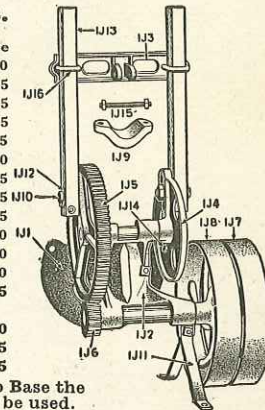

When using the J1 Sub Base the J11 Braces are not to be used.

Double Geared Belt Driven Pump Jack Parts.

Part No.	Description	Price
J1	*Main Base.....	\$2.00
J2	*Crank Gear.....	1.25
AJ3	*Cross Head.....	.85
AJ5	*Large Gear.....	1.50
AJ6	*Small Gear with Shaft.....	1.00
J3	*Pinion.....	1.00
AJ7	*Tight Pulley.....	1.35
AJ8	*Loose Pulley.....	1.35
CJ2	*Clamp.....	.95
AJ10	*Crank Pin with Nut and Cotter Pin.....	.50
AJ12	*Crank Pin Washer.....	.05
AJ13	*Pump Arms, each.....	.75
AJ16	*Cross Head Clamp, each.....	.15
B68	*Grease Cup.....	.25
14	*Pulley Set Screw (not shown).....	.10

NOTE—All parts marked (\*) will be shipped by parcel post, postage paid. All other items will be shipped by express or freight collect.

PRICES SUBJECT TO CHANGE WITHOUT NOTICE.

## FRICTION CLUTCH PULLEYS.

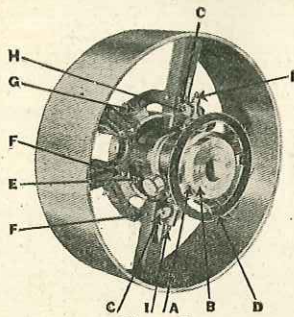

Figure 9.

A friction clutch pulley is used in place of the solid pulley, so the engine may be started or stopped without having to throw off the belt, or the machines may be stopped without stopping the engine. This clutch has interchangeable rims, which can be easily removed, so by purchasing one of these clutch pulleys with extra rims you will have an outfit that will run nearly every machine your engine can handle.

To change the pulley rims, loosen the four set screws "A" (Figure 9), remove the collar "B". Then take out the bolts "C" and remove the hand wheel and collar "D". Pull out the Friction Spider "E". Take out the cotter keys and drive out pins "F". This will free the friction blocks "G" and the adjusting arms "H". Your pulley is now completely dismantled. To build up the new pulley, take the new rim and simply reverse these operations. The pulley is very easily adjusted by means of the adjusting bolts "I", but be sure and adjust them evenly so the bearing will be the same on all the blocks.

The pulley will stand still when the hand wheel "D" is pushed in. To start the machine pull the hand wheel "D" out slowly, as this throws the load on the pulley gradually and will lengthen the life of your pulley.

Parts Heavy Pattern Bierman Clutch Pulley.

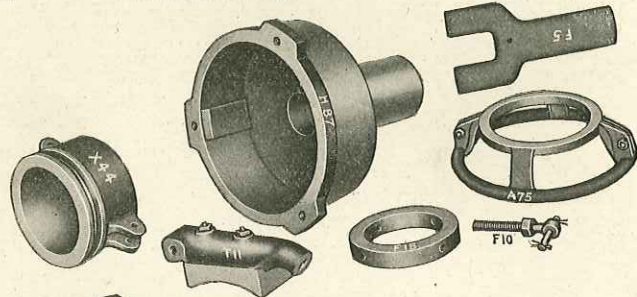

Parts Light Pattern Bierman Clutch Pulley.

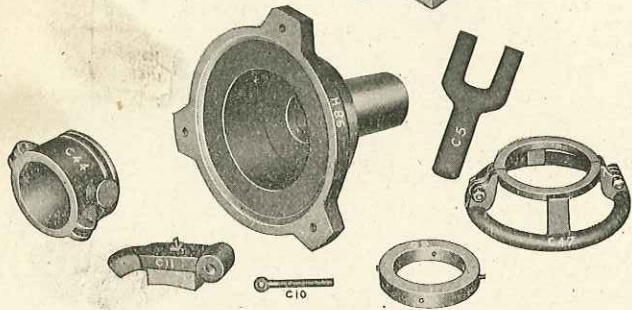

## CLUTCH PULLEY PARTS.

Be sure when ordering parts for clutch to give the diameter and face of pulley rim.		Be sure when ordering parts for clutch to give the diameter and face of pulley rim.	
LIGHT PATTERN		HEAVY PATTERN	
Face Pulleys	Price on 6"	Face Pulleys	Price on 8"
H-86 Friction Spider.....	\$12.00	H-87 Friction Spider.....	\$15.00
C-44 Sliding Sleeve.....	4.50	F-5 Adjusting Arm.....	1.50
C-5 Adjusting Arm.....	1.15	F-6 Knuckle Joint (not shown).....	.75
C-11 Brake Shoe with Block.....	1.50	X-44 Sliding Sleeve.....	6.00
C-10 3/4 Adjusting Eye Bolt.....	1.75	F-10 1/2x3" Eye Bolt.....	1.15
C-9 Set Collar for H-86 (not shown).....	1.50	T-11 Brake Shoe with Block.....	2.00
C-6 Knuckle Joint in C-5 (not shown).....	.75	A-75 Split Hand Wheel.....	2.65
C-47 Split Hand Wheel.....	2.25	F-15 Friction Collar for H-87 (not shown).....	2.65
C-1 Shoulder Bolt for Brake Shoe (not shown).....	1.15	Friction Block for T-11.....	.50
Block for C-11.....	.40		

PRICES SUBJECT TO CHANGE WITHOUT NOTICE.

## CLUTCH PULLEY RIMS ONLY.

3, 5 and 7-H. P.	8x6	12x6	16x6	9 and 12-H. P.	16x8	20x8	24x8	28x8
	10x6	14x6			18x8	22x8	26x8	30x8

Six-inch face pulleys must not be used on 9 or 12-H. P. engines.

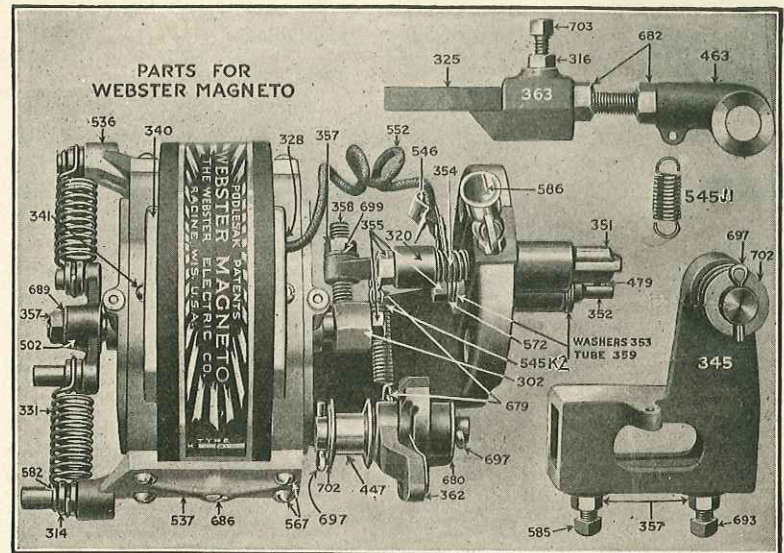

Part No.	Description	Price	Part No.	Description	Price
302	Push Finger.....	\$0.50	536	Magnet Clamp (short pin).....	\$0.25
303	Bracket, complete (not shown).....	5.00	537	Magnet Clamp (long pin).....	.25
314	Spring Roller.....	.15	542	Key (Shafts or Electrode (not shown).....	.05
316	Nut for Set Screw.....	.05	545J1	Journal Spring.....	.20
320	Electrode Arm.....	.25	545K2	Electrode Arm Spring.....	.20
325	Push Rod.....	.30	546	Plug Terminal—Bronze.....	.15
328	Fiber Bushing.....	.05	552	Terminal Wire.....	.10
331	Inductor Spring.....	.10	567	Clamp Screw.....	.05
339	Shaft Washer (not shown).....	.05	572	Electrode Washer.....	.05
340	Top Cover.....	.35	577	Starting Lever (not shown).....	.20
341	Cover Screw.....	.05	582	Split Ring.....	.05
345	Valve Rod Clamp.....	.75	585	Set Screw (sharp point).....	.05
351	Movable Electrode and Point.....	.75	586	Priming Cup.....	.35
352	Stationary Electrode and Point.....	.60	679	Spring Cotter Pin.....	.05
353	Insulating Washer.....	.05	680	Eccentric Washer.....	.05
354	Electrode Spring.....	.20	682	Push Rod Nut.....	.05
355	Nut.....	.05	686	Magnet Bar Set Screw.....	.05
357	Nut.....	.05	689	Washer for Spring Arm Nut.....	.05
358	Adjusting Screw.....	.10	693	Set Screw (cup point).....	.05
359	Mica Tube.....	.20	697	Eccentric Cotter Pin.....	.05
362	Control Lever.....	.75	699	Adj. Screw Lock Washer.....	.05
363	Wedge.....	.20	702	Roller Washer.....	.05
447	Push Rod Roller.....	.20	703	Wedge Set Screw.....	.05
463	Push Rod Journal.....	.30			
479	Spark Points.....	.20			
502	Spring Arm.....	.50			

NOTE—All items shipped by parcel post, postage prepaid.

PRICES SUBJECT TO CHANGE WITHOUT NOTICE.

## THE WEBSTER MAGNETO.

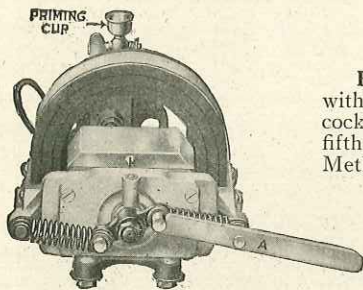

Figure 11.

**Figure 12.** This is a line drawing of the tripping mechanism showing how it should be set for proper running. It also shows the timing lever "J." Be sure when starting the engine that this is pushed to the right as far as it will go. This retards the spark and prevents the engine from kicking back when starting.

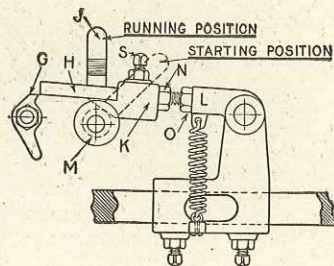

Figure 12.

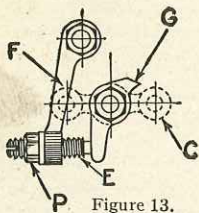

Figure 13.

**Figure 13.** Shows the push finger "G" and movable electrode adjusting screw "E" that controls the position of the igniter points on the inside of the engine. This screw must be kept in proper adjustment, as explained at the top of page 31, so as to take up any wear on the push finger or the igniter parts.

**Figure 14.** This is a line drawing showing the position that the connecting rod and crankshaft should be in just before the piston is thrown back against compression when starting, as explained in the fourth paragraph under the heading, "Second Method of Starting," on the opposite page.

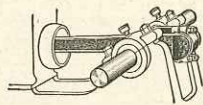

Figure 14.

### FIRST METHOD OF STARTING GASOLINE ENGINE WITH MAGNETO.

**First.** Open the needle valve on mixer two full turns to the left, close the air damper, turn on the oil by raising the lever on the lubricator and be sure the oil is dropping properly.

**Second.** Place the timing lever "J" (Figure 12) in the starting position. This retards the spark and prevents the engine from kicking back when you start it.

**Third.** Turn the flywheels to the right until the detent blade on the governor can be pushed in behind the catch block on the cam rod and hold it there.

**Fourth.** Take hold of a spoke in the flywheel and turn it around to the right rapidly five or six times and then release the detent blade, but continue to turn the flywheel until the engine starts.

**Starting cranks furnished with 1½, 3, 5 and 7 horse power engines only.**

**Fifth.** As soon as engine starts open the air damper, change the timing lever "J" (Figure 12) to the running position and close the fuel valve slowly until the point is reached where the engine runs with the least number of explosions and without black smoke appearing at the exhaust or a popping sound at the mixer, the latter being caused by an insufficient supply of fuel, and smoke at the exhaust by too much fuel.

### SECOND METHOD OF STARTING GASOLINE ENGINE WITH MAGNETO.

This does not apply to the 1½-horse power as no priming cup is furnished on that size.

**First.** Open the priming cup to relieve compression and turn on the oil by raising the small lever on top of the lubricator.

**Second.** Place the timing lever "J" (Figure 12) in the starting position and turn the flywheels to the right until the igniter trips, then stop.

**Third.** Prime the cylinder by filing the priming cup four times with gasoline and let it run into the cylinder, then close the cup. If the engine has been running and is still hot only fill the cup once.

**Fourth.** Open needle valve on the mixer two full turns to the left, close the air damper and then turn the flywheel to the right one-half turn or until the crank is on the outer dead center, as shown in Figure 14.

**Fifth.** Cock the springs on magneto with tripping lever "A," as shown in Figure 11.

**Sixth.** Take hold of a spoke in the flywheel at the top with your right hand and put your right foot on a spoke at side nearest the magneto, pull with your hand and push with your foot, giving the flywheel a quick turn back toward the cylinder, at the same time pushing down on the tripping lever "A" with your left hand, and the engine should start.

**Starting cranks furnished with 1½, 3, 5 and 7 horse power engine only.**

**Seventh.** As soon as engine starts open the air damper on the mixer, shift the timing lever "J" to the running position and close the fuel valve slowly until the point is reached where the engine runs with the least number of explosions, as explained above.

### TO STOP THE ENGINE.

As there are no batteries used on the magneto equipped engines, you do not have to open the switch or break the circuit to stop the engine, just shut off the gasoline by closing the needle valve on the mixer. Turn the small lever on top of the lubricator down, which shuts off the oil, and drain the water out of the cylinder if the weather is cold, to prevent freezing.



## HOW TO TEST THE MAGNETO TO SEE IF IT IS FURNISHING A SPARK.

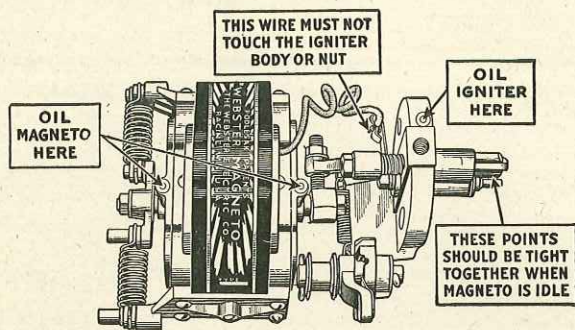

Figure 15.

Remove magneto and the igniter plug as shown above from engine without taking the magneto off the bracket. Trip the magneto with tripping lever the same as when starting the engine. If no spark occurs at igniter points it may be that the insulation on the stationary electrode is broken and should be replaced. (See list of repairs, page 27, No. 353 and No. 359.) Also see that the igniter points are together. If the points are apart, adjust them by loosening locknut "P" and turning adjusting screw "E" (Figure 13, page 28) until the igniter points are together.

If you want to run the engine with a battery instead of magneto, loosen locknut "P" and tighten the adjusting screw "E" (Figure 13, page 28) until the igniter points are separated about the thickness of a postal card, then tighten the locknut "P."

When attaching battery, use a make and break spark coil connected between the battery and the engine and use a switch so you can shut off the current. Attach the wire that comes from the coil to the terminal on the igniter (Figure 15) and the other wire to the bracket bolt under the magneto. Do not take off the magneto.

### CARE OF MAGNETO.

The magneto, being a mechanical device, requires the same attention regarding lubrication as does the engine itself. The two main bearings of the magneto have wick oilers fed from reservoirs that should be filled with sewing machine or cream separator oil once every two weeks. **Oil trip roller frequently and the four spring roller pins whenever you use the engine.**

Use very light oil on the magneto and igniter, and if electrode should stick clean it with kerosene. Igniter points may be cleaned without removing the igniter by sliding the movable electrode back and forth from the outside.

**Never remove the magnets from the magneto, as they will immediately lose their strength. Do not take the magneto apart.** It contains absolutely no brushes or rubbing contacts of any kind, so there is nothing inside that can get out of order. We do not guarantee the magneto if you take it apart. If you think there is anything wrong write us.

If ever necessary to return magneto, be sure and return bracket complete also.

## HOW TO SET THE SPARK WHEN MAGNETO IS USED FOR IGNITION.

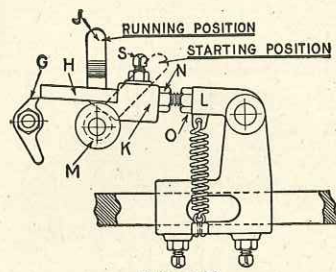

Figure 16.

**First and IMPORTANT.** The adjusting screw "E" as shown in Figure 17 should always be set so it will just touch the push finger "G" when the spring arm "C" is in a horizontal position. If screw "E" does not touch push finger "G" or if it is set too far you will only get a weak spark.

**Second.** Be sure timing lever "J" shown in Figure 16 is in running position, then turn the flywheels to the right until the piston starts back into the cylinder on the compression stroke, then continue to turn them slowly until the word **Spark** on the rim of the flywheel is opposite the top of the cam rod (Figure 18). This is the point at which the spark should be made.

**Third.** Place the tripping lever "A" (Figure 11, page 28) on the magneto and cock the springs as shown.

**Fourth.** See that the screws (Figure 16) which fasten the clamp to the push rod are tight and that the one nearest the cylinder head is in the hole in the bottom of the cam rod, then adjust the length of push rod "H" (Figure 16) until the end of the rod touches the push finger "G." Tighten locknut "O".

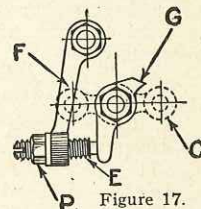

Figure 17.

**Fifth.** Loosen set screw "S," move wedge "K" on the push rod toward the magneto until the lower edge of the end of the rod "H" is just even with the upper edge of the magneto push finger "G" as shown, tighten set screw "S," then the locknut "N."

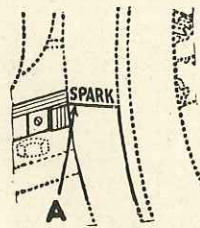
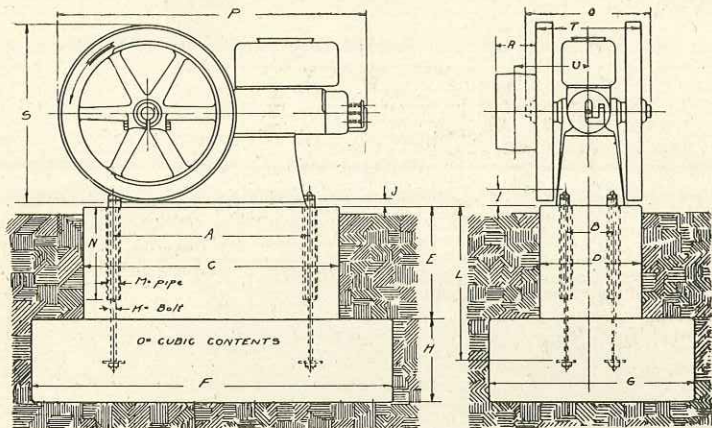

Figure 18.

**Sixth.** Take off the tripping lever, be sure the magneto wire is fastened to the terminal (Figure 15, page 30). Turn the flywheels to the right to see if the magneto trips off when the word **Spark** is opposite the top of the cam rod. If not, adjust the wedge "K" (Figure 16) carefully until it does. To make engine fire earlier, move wedge "K" toward magneto. To fire later, move wedge "K" away from magneto.



Measurements

MODEL "E."

ENQ.	A	B	C	D	E	F	G	H	I	J	K	L	M	N	O <sub>1</sub>	P	Q	R	S	T	U
1½ H.P.	20"	5½"	29"	14"	12"	4"	26"	12"	1½"	3"	10"	1"	10"	10"	10"	30"	19"	4"	10"	13"	9"
3 H.P.	25"	6½"	36"	18"	10"	4"	30"	12"	2"	1½"	24"	1"	15"	15"	14"	39"	21"	4"	22"	16"	11"
5 H.P.	29"	8"	42"	20"	10"	5"	34"	12"	2½"	1½"	24"	1½"	15"	22"	44"	24"	4"	20"	19"	12"	14"
7 H.P.	36"	9"	48"	20"	10"	6"	38"	10"	2½"	1½"	27"	1½"	15"	36"	56"	26"	6"	34"	20"	13"	13"
9 H.P.	41"	10"	54"	22"	10"	7"	44"	10"	2½"	1½"	33"	1½"	20"	52"	44"	28"	8"	38"	23"	15"	14"
12 H.P.	47"	12"	62"	25"	10"	8"	50"	10"	2½"	1½"	33"	1½"	20"	66"	73"	31"	8"	44"	26"	17"	

#### MOUNT THE ENGINE ON A SOLID FOUNDATION.

These engines are very evenly balanced, and run with very little vibration, but wherever possible it is a good plan to mount your engine on a concrete foundation, or if you cannot do this, use heavy timbers securely fastened down.

When an engine is to be located permanently it is best to mount it on a concrete foundation as shown above. In the table each letter shows the distance between the points as indicated in the drawing above.

To make a foundation like this dig a hole as long and wide as indicated by "F" and "G" and as deep as the sum of "E" and "H." If ground is not solid lime hole with lumber or sheet metal to prevent caving. Make a box without top or bottom of size as indicated by C, D and E. Across the top of this box securely attach a couple of strips 2 or 3 inches wide, thickness as indicated by "J" and spaced as indicated by "A," measuring from center to center. These strips should be long enough to reach clear across the hole for foundation and box hung in the center of it. The top edges of box must be perfectly level. In the cross strips bore holes of size as indicated by "K" spaced as indicated by "A" and "B." Foundation bolts of length indicated by "L" fitted with large washers on the bottom should be hung from the cross strips. A piece of pipe or tubing larger than the bolt should be placed on the bolts as indicated by the dotted lines in the diagram. The pipe or tubing should come about ¼ inch below the top of the cross pieces and is put in so bolts can be shifted on account of a variation in the bolt holes in the engine base.

If engine is to be raised from ground the measurement "E" and length of bolts "L" should be increased to correspond with the height of foundation above ground, but measurements below ground must not be changed.

The concrete should be made up of one part good Portland cement, two parts clean sharp sand and four parts clean gravel or crushed stone. Mix thoroughly while dry and then add water, again mixing well till you have a good mixture. Place this in the foundation hole and fill up to within ¼ inch of the top of the box. Then fill the remaining space with a mixture of one part cement and two parts sand mixed thoroughly and moistened sufficiently so it can be spread and troweled smooth. Let the foundation set for two or three days, when the wood forms can be removed and space around foundation filled with earth or cinders. Then mix cement and water about like thick cream and fill the spaces between the pipe and bolts. Mount the engine, put nuts on bolts and screw down tight. It will be best to let the foundation harden for at least a week or ten days before using the engine.

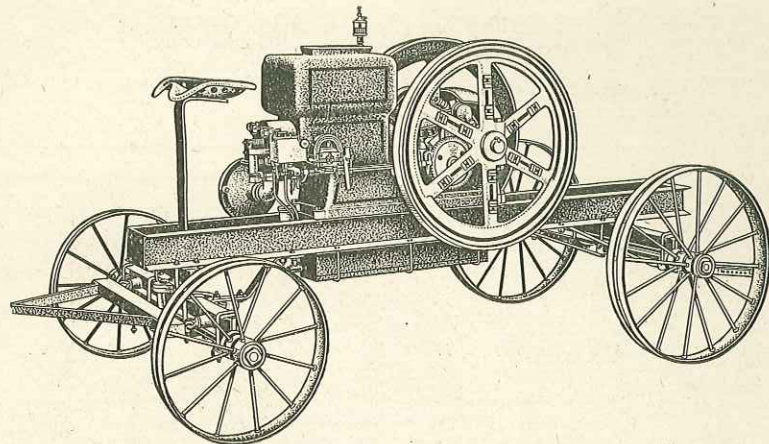

#### IF YOU DESIRE A MOUNTING ENGINE

use only the good, heavy-channelled and well-braced trucks, especially designed for the type engine we furnish. When engine is in operation put wedged blocks in front and behind each wheel. In taking up bearings on saw tables, follow instructions given on page 16.

#### CAPACITY OF FUEL TANKS.

The fuel tank of the stationary engine is located in the base. The 1½-H. P. tank holds 1 gallon; 3-H. P. 1¼ gallons; 5-H. P. 2¾ gallons; 7-H. P. 5¼ gallons; 9-H. P. 7¼ gallons; 12-H. P. 1¾ gallons.

The fuel tank of the half base mounting engine is to be fastened between the channels of the truck. The 7-H. P. tank holds 7¼ gallons; 9-H. P. 14 gallons; 12-H. P. 14 gallons.

#### RULE FOR FIGURING SIZE OF PULLEYS.

BE SURE YOU ARE USING THE RIGHT PULLEYS ON ENGINE AND MACHINES IT IS DRIVING.

The machines you run with an engine, to give you satisfactory service, must be equipped with the proper size of pulley to correspond with the pulley on the engine.

To be sure that the pulleys you are using are of the right size to give the best results, take the speed of the engine multiplied by the size of the pulley on the engine and divide the result by the speed of the machine that you want to run. The result will give you the size of the pulley you should have on the machine.

**For example:** We will say the speed of the engine is 425 revolutions per minute, the diameter of the pulley on the engine is 12 inches and you want to run a feed grinder 510 revolutions per minute.

$$425 \times 12 = 5100 \div 510 = 10 \text{ inches.}$$

The result, 10 inches, is the size of the pulley you should have on the grinder to run it 510 revolutions per minute.

If there is a pulley on the machine you want to run, to find out what size of pulley to use on the engine, take the speed of the machine multiplied by the diameter of the pulley on the machine and divide by the speed of the engine you are going to use, which will give the size of pulley you should have on the engine to give the best results.

**For example:** Suppose you had a feed grinder that you wanted to run at 510 revolutions per minute. The diameter of the pulley is 10 inches and your engine runs 425 revolutions per minute.

$$510 \times 10 = 5100 \div 425 = 12 \text{ inches.}$$

The result, 12 inches, is the size of the pulley you should have on the engine to run the grinder at 510 revolutions per minute.

Of course you understand the pulley sizes and the speed of the machine will vary a little one way or the other. When figuring the size of pulley to use, if the result shows an odd size take the nearest even size, which will be all right. For example, if the above result should have been 11½ inches, you would use a 12-inch pulley, but if the result had been 10½ inches, then a 10-inch pulley should be used. In case the result should be just half way between regular sizes, we advise using the next larger even size.

If you are not sure as to just what size pulley to get, write and tell us what you want to do and we will tell you the size you need.

# GASOLINE ENGINE

CONSIDER THE QUALITY BENEATH THE PAINT

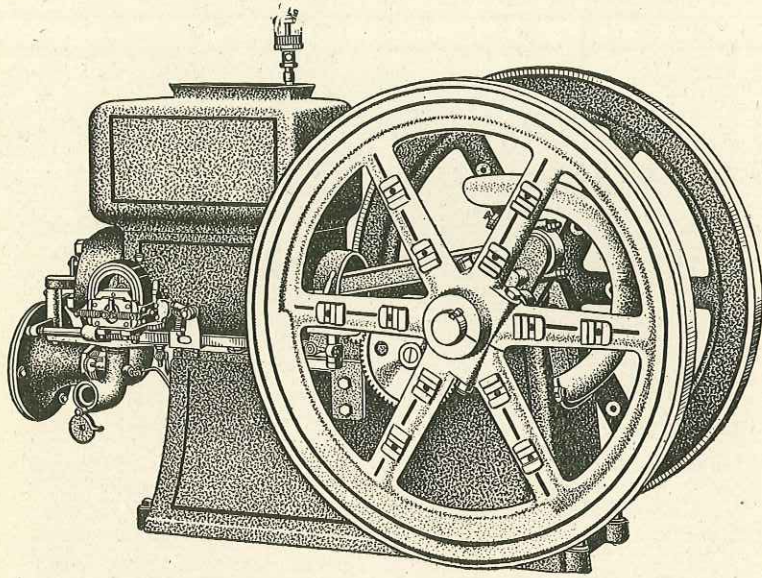

**CRANK SHAFT**—Drop forged high carbon steel. 10% oversize. Turned and ground.

**GEARS**—Governor gear and crank shaft gear are cut from solid blocks of steel.

**BEARINGS**—White Bronze, die cast removable and interchangeable. Best automobile motor bearings are exactly the same. Compare this with cheap babbitt, melted and poured into the rough castings around the shaft, the method used in the manufacture of practically all other low-priced engines and a great many of the high-priced ones.

**GOVERNOR WITH SPEED CHANGING DEVICE**—High-speed fly-ball type as used on highest-priced engines. Equipped with speed changing device that enables the operator to change the speed 125 R. P. M. while engine is in operation by merely shifting a vertical lever.

**FINISH**—All castings are ground smooth, given several coats of filler, thoroughly sanded, painted and varnished, producing a wonderfully smooth and attractive finish.

Every man takes pride in realizing the fact that he has made a good purchase. Our customers do our advertising.

# High Quality

From its inception this engine has held the foremost position in the Gas Engine industry. Commencing when the industry was in its infancy, it has been manufactured upon well-defined principles. Those principles have always been closely followed, with the result that our factory has grown to be the largest and best equipped Gas Engine plant in the world, and our line has been firmly entrenched in its commanding position.

This plant in its equipment of fine machinery, fine tools, jigs, fixtures and appliances is not equaled in the gas engine industry. This equipment includes a large battery of automatic labor-saving machines. Of these, many are capable of turning out from two to ten times the volume of work produced by the ordinary methods—an important factor in making possible the price, and an important factor in making possible the quality.

The system of inspection is so exacting that it practically precludes the possibility of an imperfect part being incorporated in the engine so far as can be detected by the most accurate measuring instruments known to engineering science. From the time the raw materials reach the warehouse and foundry until they leave the plant in the finished product, they are under the careful scrutiny of a corps of experts trained in accordance with the high standards of the organization. This inspection extends to the smallest pieces, including nuts, bolts and screws.

This engine has never had embodied in its makeup, features whose value was confined to their use as "talking points." It finds its sale not especially among purchasers whose limit of investment is the price. It appeals alike to the discriminating buyer who demands a dollar's worth for every dollar of investment, and to the buyer who places dependability and service above all price consideration.

It is the most sturdy and dependable of all gas engines. It is an engine of enduring service. In economy of operation and maintenance there is none that enjoys a favorable comparison with it. In real and substantial gas engine value it has no equal.

When in the Market  
for a Buggy

*Write to*

**THE HERCULES BUGGY CO.**  
EVANSVILLE, IND.



And When Your Friends  
Are in the Market for a  
Gasoline or Kerosene  
Engine, We Will Appreciate  
Your Telling Them to

*Write to*

— THE —  
**HERCULES GAS ENGINE CO.**  
EVANSVILLE, INDIANA

WOODWARD



## BE YOUR OWN EXPERT

---

---

☐ Hercules has removed all fear of trouble with his engines by giving every owner an opportunity to become a MASTER of his engine in a few very simple lessons.

☐ Call and see your dealer at once for full particulars on our

